

Machter Autoparts

03.06.2017

Machter Autoparts

WWW: <http://www.machter.com.au>

E-mail: sales@machter.com.au

Phone: 02 8850 1111

Unit E, Gate B, 21 Loyalty Road, North Rocks, NSW 2151

Contents

Code	Description	Price	Page	Note
AIR CLEANER INTAKE HOSE			41	
AIH-MA001	Mazda 323 1.8L 2.0L Astina 98-03 BJ Air Cleaner Intake Hose & Ford KN KQ Laser		41	
AIH-MA002	Air Cleaner Intake Hose Mazda 323 1.6L Astina BJ 98-03 & Ford KN KQ Laser		41	
AIH-TA001	Air Cleaner Intake Hose Landcruiser HZJ80 HZJ81 1HZ 4.2L Diesel 80 Series		41	
AIH-TA002	Air Intake Hose Landcruiser 1FZ 4.5L FZJ75 FZJ80 8/1992-1998 75 80 Series Petrol		41	
AIH-TA003	Air Intake Hose Hilux LN106 LN107 LN111 LN130 LN85 LN86 1988-97 2L 3L Diesel		42	
AIH-TA004	Air Intake Hose Hilux 1997 to 8/2000 LN147 LN167 LN172 5L 3.0L Diesel Engine Ute		42	
AIH-TA008	Air Intake Hose Toyota Camry SXV10 1993-1997 5S-FE 2.2L 2164cc Engine		42	
AIH-TA009	Engine Air Cleaner Intake Hose Hilux 2L Diesel LN55 LN56 LN60 LN61 LN65 1983-89		42	
AIH-TA010	Air Intake Hose Toyota Landcruiser HZJ70, 73, 75, 78, 79 4.2L 1HZ Diesel 1990-2007		43	
AIH-VW001	Vw amarok high performance air intake hose		43	
AIR COMPRESSOR SWITCH			43	
APS-PSI120	90-120PSI Air Compressor Pump Pressure Switch		43	
APS-PSI175	145-175 PSI Air Compressor Pump Pressure Switch		43	
AIR HORN			44	

Code	Description	Price	Page	Note
AHORN-001	150db 12V Super Loud Dual Trumpet Air Horn Horns For Truck Mega Train Chrome		44	
AHORN-002	150db Truck Mega Train Single Trumpet Air Horn Kit w DC 12V Compressor		44	
RAHORN-001	Back Up Horn Reversing Alarm / Reverse Siren Beeper Buzzer Warning Alert 12 Volt		44	
ALTERNATOR			45	
ALTER-HLN001	Alternator fits Holden Commodore V6 VS VT VU VX VY 3.8L Sedan Wagon Ute		45	
ALTER-HLN002	NEW ALTERNATOR TO FIT HOLDEN COMMODORE 5.0L V8 VL VN VR VS VG VQ		45	
ALTER-HLN004	Alternator Holden Commodore V8 HSV VZ VE V8 GEN4 GEN5 12V 140A 2 Pins Plug 6.0L		45	
ALTER-HLN005	Alternator Fit Holden Commodore V8 GEN 3 LS1 VT VX VY VU WH WK WL 5.7L HSV 140A		45	
ALTER-NS001	New 80Amp Alternator to fit Nissan Patrol GQ GU 4.2L Diesel (TD42) 1988 to 2003		46	
ALTER-TA001	New Alternator to fit Toyota Landcruiser 1HZ 4.2L Diesel 80 Series & 100 Series		46	
ALTER-TA002	Alternator to fit TOYOTA HiLux D4D KUN16R KUN26R Turbo Diesel 1KD-FTV 3.0L 05-14		46	
ALTER-TA003	Alternator - Toyota Landcruiser 4.0L Diesel 2H 1980-1990 HJ60 HJ75 # 27020-68140		46	
ALTER-TA004	Alternator Fit Toyota Landcruiser 4.0L Diesel 2H 1980-90 HJ60 HJ75 Internal Reg		47	
ALTER-TA005	Alternator TOYOTA HILUX 2.8L (3L) 2.4L (2L) DIESEL 1985-1993 High Output 80AMP		47	
ALTER-TA006	Alternator fit Toyota Landcruiser FZJ80 engine 1FZ-FE 4.5L Petrol 92-05		47	
ALTER-TA007	Alternator Toyota 2AZ-FE RAV4 ACA33R ACA38R engine 2.4L Clutch Pulley 130A 06-14		47	

Code	Description	Price	Page	Note
ALTER-TA008	Alternator suit Toyota Hiace Hilux LN106 107 111 167 172 eng 3L 5L Diesel 91-05		48	
ALTER-TA009	Alternator To Suit Toyota Hilux 2.4L (2L) 2.8 (3L) Diesel 85-93 (INTERNAL REG)		48	
BALL JOINTS			48	
BJ-BA3263-A	AU BA BF Ford Upper Ball Joints Set Front Falcon Fairlane BA3263-A 2pcs Express		48	
BJ-BA3395-A	Front Lower Ball Joints Ford Falcon AU BA BF Fairlane BA3395-A Sedan Wagon Ute		48	
BJ-FD425	Falcon AU-1/2/3 BA BF Upper Front Ball Joints Ford Fairlane LTD BJ425 *Express*		49	
BJ-FD426	AU BA BF Ball Joints Ford Falcon Fairlane LTD Front Lower 2pcs BJ426 *Express*		49	
BJ-FD317	Ford Ball Joints Kit Fairlane NA-NL Falcon EA-EL LTD DA-DL1988-1998 BJ317 Upper		49	
BJ-FD318	Ford Ball Joints Kit Lower NA-NL Fairlane EA-EL Falcon DA-DL LTD 88-98 BJ318		49	
BBQ TOOL			50	
BBQT-001	BBQ Tool Scraper Grill Cleaning 5 in 1 multi Steam Cleaner bottle opener Steel		50	
BEARING HUB			50	
WH-FD001	RONT WHEEL BEARING HUB SUIT FORD FALCON XR6 XR8 AU BA BF INC FPV		50	
WHLN-FD001	Ford Falcon Nuts & ILJIN Front Wheel Bearing Hubs AU/BA/BF SEDAN WAGON UTE		50	
WH-HLN001L	V6 VU VZ Commodore Left Front Wheel Bearing Hub Holden VT 2 VY VX V8 ABS 3.8L		51	
WH-HLN001R	Front Wheel Bearing Hub Holden Commodore Calais VT Series 2 VX VY VZ V6 ABS RH		51	

Code	Description	Price	Page	Note
WH-HLN002	FW Hubs Isuzu DMax D-Max Holden Rodeo Jackaroo Colorado RG Frontera 4WD Trooper		51	
WH-HLN003	Holden Astra Rear Wheel Bearing Hub L&R Petrol Diesel 04-10 ABS AH 5 Stud 1.8L		51	
WH-JP001	FRONT HUB WHEEL BEARING SUIT JEEP CHEROKEE XJ 4.0L PETROL 1984 - 2001 4WD WAGON		52	
WH-NS004KIT	Free Wheeling Hub Reinforcing Rings For Nissan Patrol GQ GU		52	
WH-NS006	1 FRONT WHEEL BEARING HUB NISSAN NAVARA 4WD D22 D40 YD25/VQ40 ABS SPANISH 05-12		52	
WH-MB002	2pcs Free Manual Wheeling Hub Lock Mitsubishi Triton Pajero 28 Splines 88mm PCD		52	
WH-MB003	Front Wheel Bearing Hub Suit For Mitsubishi Pajero NM, NP, NS, NT 05/2000-2009		53	
WH-NS007	FRONT WHEEL HUB KIT ELGRAND E51 02-10 INFINITI FX45/35 (S50) 02-08 43210-WL000		53	
WH-NS008	Front Wheel Bearing Hub Nissan Navara D40 D22 2.5TDI 4.0 YD25 Thailand Build ABS		53	
WH-SU001	SUZUKI VITARA PAIR OF FREE WHEEL BEARING HUBS (2 OF) 1988 ONWARDS BRAND NEW		53	
WH-SR001	1 x FRONT WHEEL HUB FOR LEGACY OUTBACK B12 1997-2003 28362-AE000		54	
WH-TA001	FREE WHEELING HUBS TOYOTA LANDCRUISER 105 79 SERIES FZJ105 HDJ105 HZJ105 HZJ79		54	
WH-TA003	2pcs Free Wheeling Wheel Hub Lock Manual Lock 26 spline Toyota Hilux 4WD 79-85		54	
BLOWER MOTOR RESISTOR			55	
HFR-HD001	8 Fins Honda CRV Blower Motor Heater Fan Resistor 2001-2006 077800-0710		55	
HFR-HLN001	Holden Colorado Isuzu D-Max Nissan Maxima RC Blower Motor Heater Fan Resistor		55	

Code	Description	Price	Page	Note
HFR-NS001	Navara D40 Blower Motor Heater Fan Resistor Pathfinder R51 Manual 2005-2013		55	
HFR-NS002	Nissan Pulsar N15 Navara D22 Blower Motor Heater Fan Resistor Manual Climate		55	
HFR-NS003	Blower Motor Heater Fan Resistor for Pathfinder R50 95-04 Patrol GU 97-13		56	
HFR-NS004	Nissan Blower Motor Heater Fan Resistor X-Trail T30 Maxima A33 27761-9W100 NEW		56	
HFR-NS005	Blower Motor Heater Fan Resistor for Nissan X-Trail T30 27150-8H300 2001-ON		56	
BONNET GAS STRUTS			57	
ABS-HLN001	Holden Commodore VE Rear Wheel Speed ABS Sensor and Statesman WM 92211237 New		57	
BS-BZ001	Gas Bonnet Struts for Mercedes Benz W163 Series ML55 ML270 ML350 ML430 Set of 2		57	
BS-FD001	Ford Falcon ED EF EL EA EB Gas Bonnet Struts Fairmont 88-98 Lift Support New Set		57	
BS-FD002	2x Tailgate Struts Gas Springs Boot Set for Ford Focus Hatchback MK2 2005-2010		57	
BS-FD003	Pair Bonnet Gas Struts Ford BA BF Falcon FPV XR6 XR8 GT GTP Fairlane 2002-2008		58	
BS-HLN001	HOLDEN COMMODORE STATESMAN GAS BONNET STRUTS SUIT SS VT VX VU VY VZ WH WK WL		58	
BS-HLN002	Holden Commodore VT VX VU VY VZ Wagon Tailgate Gas Struts Rear Left & Right		58	
BS-JP001	Jeep Grand Cherokee Gas Tailgate Struts Pair WJ WG 99-2004 Laredo Sport Limited		58	
BS-NS001	Nissan GU Patrol 1997+ Heavy Duty Bonnet Gas Struts - Brand New Pair		59	
BS-NS002	Bonnet Gas Strut fit Toyota Hilux Vigo SR5 Hood Damper Lift Kit 2005-2012		59	

Code	Description	Price	Page	Note
BS-TA001	1 Pair Front Bonnet Gas Struts Toyota Landcruiser 80 Series 90-97 Lift Support		59	
BS-TA002	Toyota Landcruiser Gas Bonnet Struts 100 Series FZJ HDJ HZJ 6/98-2007 New Pair		59	
BS-TA003	Toyota Landcruiser 80 Series Tailgate Gas Struts 90-97 / Springs Rear Left Right		60	
BS-TA004	Pair Front Bonnet Gas Struts Toyota Landcruiser Prado 120 Series 2002-2009		60	
BS-TA005	Gas Bonnet Strut Toyota Camry ACV40 AHV40 Aurion Sedan 06-11 Lift Support Kit		60	
BS-TA006	Nissan Navara D40 05-13 Bonnet Gas Struts Damper Kit Pair- Thai or Spain Build		60	
BS-TA007	TAILGATE GAS STRUTS 100 SERIES TOYOTA LANDCRUISER REAR 98-07 Rear Left and Right		61	
BS-TA008	Set of 2 Bonnet Gas Struts for Toyota Camry MCV20 SXV20 Sedan Wagon 1997-2001		61	
BRAKE HOSE			61	
BH-NS001	Extended Brake Lines Hose Kit fits 2"-5" spring lift Nissan Patrol GQ Y60 GU Y61		61	
BH-NS003004	Extended Brake Hose/Line kit - for Nissan Patrol GQ (Y60) GU (Y61) Maverick		61	
BH-NS005006	Extended Stainless Braided Brake Lines Nissan Patrol GQ Y60 GU Y61 2-8" Lift Kit		62	
BH-NS007	Braided' Extended Brake Hose/Line kit - for Nissan Patrol GQ (Y60) GU (Y61)		62	
BH-NS008	Brake Caliper Hose SET (Front & Rear) - for Nissan Patrol GQ Maverick (88-97)		62	
BH-NS009	Brake Caliper Hose SET (Front & Rear) - for Nissan Patrol GQ Maverick (88-97)		62	
BH-TA001	Pair Front Brake Hoses Lines Toyota Landcruiser 60 70 75 Series HZJ75 FJ75 HJ60		63	

Code	Description	Price	Page	Note
BH-TA002	Toyota Rear Extended Brake Line Hose Hilux RN46 YN65 YN67 RN105 LN106 4Runner		63	
BH-TA003	Set 2 Front Extended Brake Hose Line Hilux 4x4 LN106 RN105 LN65 YN65 YN67 88-97		63	
BRAKE MASTER CYLINDER			64	
CMC-NS005	Clutch Master Cylinder fit Nissan GQ Y60 Patrol Ford Maverick DA w/Booster 4x4		64	
CMC-TA001	Clutch Master Cylinder BJ70 BJ73 FJ70 FJ73 HJ75 Toyota Landcruiser 70 Series		64	
CMC-TA003	New Toyota Clutch Master Cylinder Landcruiser BJ42 FJ40 FJ45 FJ60 31410-60050		64	
CMC-TA004	LN106 LN107 LN111 Clutch Master Cylinder Toyota Hilux Diesel 88-97 31410-35250		64	
CSC-NS001	Nissan & Ford Clutch Slave Cylinder Patrol GQ Maverick DA Y60 4.2L 30620-01J01		65	
CSC-TA002	Clutch Slave Cylinder TOYOTA CROWN YS GS LS JZS13 LEXUS IS I 31470-30270		65	
BUSH			65	
BUSH-BMW001	Control Arm Wishbone Front Lower Bush Kit BMW E46 316 318 320 323 325 330 96-06		65	
BUSH-NS001-NS002	Panhard Rod Rubber Bush Kit Fit Nissan Patrol GQ Y60 GU Y61 Front & Rear Ute 4x4		65	
BUSH-NS003	Rear Upper Lower Control Trailing Arm Bush Kit for Nissan Patrol GQ Y60 GU Y61		66	
BUSH-NS004	Nissan & Ford Radius Arm Rear Rubber Bush Kit Patrol GQ GU Y60 Y61 Maverick DA		66	
BUSH-NS005	Patrol GQ GU Radius Arm Bush Kit Front fit Nissan & Ford Y60 Y61 DA 48705-60050		66	
CARBURETTORS			67	

Code	Description	Price	Page	Note
CARB-GY6001	GY6 PD24mm Carburetor Carb ATV Buggy Quad Scooter Go Kart 110cc 125cc Buggy		67	
CARB-KIT001	Carburetor Carby Rebuild Kit Honda CT110 Postie Posty Bike All Models		67	
CARB-PZ019	PZ19mm Lever Choke Carburetor Carb Carby 90cc 110cc 125cc ATV Bike Dirt Pit Quad		67	
CARB-PZ022	PZ22 22mm Carby Lever Choke Carburetor 110cc 125cc PIT Quad Dirt Bike ATV Buggy		67	
CARB-PZ026	PZ 26mm Lever Choke Carby Carburetor 125 140 150cc PIT PRO Trail Dirt Quad Bike		68	
CARB-PZ030	PZ30 30mm Lever Choke Carburetor Carb Carby 150cc 200cc 250cc ATV Bike Dirt Pit		68	
CYL-PW050	Yamaha Engine Rebuild Kit Head Bore Cylinder Barrel Piston Ring PW50 PY50 PW60		68	
CYLRKIT-PW050A	Engine Head Bore Barrel Cylinder Piston Rings YAMAHA PW50 PY50 PEEWEE Bike 40mm		68	
CENTER BEARING			69	
CB-HLN001	1 x Holden Commodore Tailshaft Centre Bearing VX VY VZ V8 Sedan		69	
CB-MB001	Mitsubishi Centre Bearing Mount Support Triton ME MF MG MH MJ MK L200 Ute 4x4		69	
CB-NS001	Centre Bearing Support Nissan Navara D21 D22 Driveshaft Frontie Pathfinder Ute		69	
CB-TA001	Toyota Hilux Centre Bearing RN60 RN63 RN65 RN105 4x4 Petrol Carrier Assembly		69	
CB-TA002	Toyota Hilux Tailshaft Centre Bearing Ute RWD 1983-97 LN RN YN Series Pickup		70	
CB-TA003	Toyota Driveshaft Centre Cushion Bearing Assembly Crown MS122 MS123 MS125 83-88		70	
CB-TA004	Driveshaft Centre Bearing Toyota Hilux 4x4 KZN165 RZN169 RZN174 VZN167 VZN172		70	

Code	Description	Price	Page	Note
	CLIP		71	
CLIP-001	Car Door Trim Panel Rivet Fasteners Fender Clips 10mm Hole 100 Pcs for Toyota		71	
CLIP-002	40 Black Plastic Rivet Interior Trim Panel Car Door Retainer Clips Push 8mm Hole		71	
CLIP-003	100 Bumper Bar Inner Guard Radiator Cowl Air Box Scrivet Clip Holden 92138218		71	
CLIP-FD001	10PCS Plastic Mud Flap Retainer Clip Ford Falcon AU BA BF FG XR6 XR8 G6E Turbo		71	
CLIP-FD002	50 x Plastic Clip Retainers For Ford EL EF AU BA BF FG XR6 XR8 G6E Turbo Falcon		72	
CLIP-FD003	FORD FALCON + TERRITORY 100 SET SCRIVETS CLIP PLASTIC PINS AU BA BF FG SX SY SZ		72	
CLIP-HLN001	10 Push Retainer Clips Holden Commodore VE SS SV6 OMEGA HSV Bulk Lots VE Front		72	
CLIP-HLN002	100 X FASTENER CLIPS SUIT HOLDEN COMMODORE VY VE BUMPER RADIATOR COWL TRIM CLIP		72	
CLIP-MA001	Set of 10 Door Trim Panel Retainer Plastic White Clips Mazda 323 626 CX7 Premacy		73	
CLIP-TA001	Panel Flare Clips For Toyota Land Cruiser Prado 120 Front Body Trim Mould Repair		73	
CLIP-SR001	5 x Subaru 10mm Hole Bumper Fastener Clip Door Boot Trim Panel Plastic Rivet		73	
	COIL SPRING		74	
CS-NS001(2PCS)	Nissan PATROL GQ GU Y60 Y61 30mm FRONT Coil Spring Spacers Lift Kit 4x4 Maverick		74	
CS-NS001(2PCS)/CS-NS002(2PCS)	Coil Spring Spacer 30mm Lift Kit Nissan Patrol GQ GR GU Y60 Y61 Ford Maverick		74	
CS-NS002(2PCS)	30mm Rear Coil Spring Spacer Nissan Patrol GQ GR GU Y60 Y61 Poly Safari Maverick		74	

Code	Description	Price	Page	Note
CS-NS003(2PCS)	2 POLY REAR 50mm Coil Spring Spacer Nissan Patrol GQ GU Y60 Y61 Safari Maverick		74	
CS-NS003(2PCS)/CS-NS004(2PCS)	Pair FRONT & REAR 50mm Lift Coil Spacers Kit Nissan GQ GU Y60 Y61 PATROL 4x4		75	
CS-NS004(2PCS)	50mm Coil Spring Spacer Nissan Patrol GQ GU Y60 Y61 Maverick Poly Safari Rear		75	
CONTROL ARM KIT			75	
CAKIT-AU003	FOR AUDI A4 A6 VW PASSAT COMPLETE SET FRONT SUSPENSION CONTROL ARMS KIT		75	
CAKIT-BMW001	BMW E46 316 318 Front Lower Control Arm Bushing Kit 320 325 328 330 Z4 99-05		75	
CAKIT-BMW002	BMW Front Lower Suspension Control Arm Bushing Kits Set Tie Rod E46 2WD 323Ci		76	
CRANK ANGLE SENSOR			76	
CAS-HLN001	Crank Angle Sensor Holden Commodore V6 VN VP VR VS VT VNII 3.8L10456161 88-04		76	
CAS-HLN002	Cam Angle Sensor fits Holden Astra TS AH 1.8L X18ZE Z18XE 4Cyl CAM003 Camshaft		76	
CAS-NS001	Crank Angle Sensor fits NISSAN X-TRAIL T30 QR25DE 2.5L XTRAIL Crankshaft CAS		77	
CPS-BMW001	Cam Angel Sensor / Camshaft Position Sensors Fit For BMW E46 E39 E53 E60 E85 E90		77	
SMS-TA001	OEM Speedo Speedometer Sensor Toyota Landcruiser Land Cruiser 78 79 80 Series		77	
CV JOINT			78	
CVS-TA001	CV Shaft Toyota Hilux IFS 4x4 1988-2005 Boot Axle Joint LN107 LN111 RN110 KZN165		78	
CVS-TA002	Toyota Hilux 150 Series KUN26R GGN25R CV Joint Drive Shaft 05-09 Left + Right ball cage assembly(Normal)		78	

Code	Description	Price	Page	Note
DOOR LOCK ACTUATOR			78	
DL-GEAR	1pc Ford Door Actuator Cog Falcon AU 3 BF BA Territory Lock Actuator Gear 5.7mm		78	
DLKIT-FD	Door Lock Actuator Repair Kit FORD Falcon Series 1 2 3 AU BA BF Territory Laser		78	
DL-HD001	Power Door Lock Actuator Honda Left Front Side Civic Accord Odyssey Acura MDX		79	
DL-HD002	Honda Power Door Lock Actuator Front Right Civic Accord Odyssey CRV Acura MDX TL		79	
DL-HD003	Honda Accord Door Lock Actuator Rear Left Front Left TL LX TSX DX EX 72155SDAA01		79	
DL-HD004	Door Lock Actuator Honda Accord Front Right/ Rear Right TL TSX DX EX 72115SDAA01		79	
DL-HD005	DOOR LOCK ACTUATOR HONDA CRV ACCORD INTEGRA ODYSSEY CIVIC PILOT ACURA LEFT		80	
DL-HD006	HONDA CRV ACCORD ODYSSEY CIVIC DOOR LOCK ACTUATOR FRONT RIGHT SIDE		80	
DL-TA001	Door Lock Actuator fits Toyota Echo Scion xB Front Left Side 00-05 69120-52030		80	
DL-TA002	Door Lock Actuator fits Toyota Echo Scion xB Front Right Side 00-05 Brand New		80	
DRIVESHAFT COUPLING			81	
DSC-BOLT001	SET OF 3 Tailshaft Coupling Bolts Nut Holden Commodore VT VX VU VY VZ WH WK WL		81	
DSC-HLN001	Holden Rear Tail Shaft Rubber Coupling Disc for Commodore VT VU VX VY V6 3.8 AT		81	
EGR BLANKING BLOCK PLATE			81	
BP-FD001	EGR Blanking Plate Ford Ranger PX ZSD-422 2.2L PUMA P5AT 3.2L / Mazda BT50 B22		81	

Code	Description	Price	Page	Note
BP-FD002	EGR Blanking Plate TO Ford Ranger PX PUMA P5AT 3.2L turbo diesel 2010-ON NO Hole		81	
BP-FD003	EGR Blanking Block Off Plate Pajero L2/3/400 VM 2.5/2.8/3.2 Ford Fiat Jeep Alfa		82	
BP-FD004	EGR Blanking Plate Block off Plate - Ford Ranger 3.2 Manual / BT-50 (2011-2014)		82	
BP-FD005	EGR Blanking Plate Plate Ford Ranger PJ PK Auto or Manual 2007-2011		82	
BP-FD006	Mustang Ford EGR Block Off Delete Plate w/Gasket 1987 - 1993 5.0 5L		82	
BP-FD012	EGR Blanking Plate Mazda BT-50 2.5L & 3.0L Duratorq TDCi motor Stainless Steel		83	
BP-FD013	Mazda Bt-50 BT50 2.5 & 3.0L Duratorq TDCi EGR Block Blanking Plate with hole		83	
BP-FT001	EGR Valve Blanking Block Plate VAUXHALL 1.9 CDTi Saab 1.9 Tid 2mm 304 Steel		83	
BP-GW001	EGR Blanking Plate Great Wall V200 & X200 2011-ON 2.0L 4cyl Diesel TD with Hole		83	
BP-HD001	EGR Blanking Block Plate Honda Accord Prelude Civic Jazz Shuttle Petrol Engine		84	
BP-HLN001	EGR Blanking Block Plate Holden Colorado RC Rodeo RA 4JJ1 3.0L TD Isuzu DMAX TF		84	
BP-HLN002	HOLDEN EGR BLANKING PLATE RC COLORADO / D-MAX / DMAX / RODEO RA BLOCK OFF Isuzu		84	
BP-HLN003	4JJ1 EGR Blanking Plate Isuzu DMAX D-Max TF 3.0L turbo diesel Best Performance		84	
BP-HLN004	Holden 2.8L RG Colorado EGR Blanking Plate Late 2013-ON MY14 MY15 MY16		85	
BP-HLN005	Holden EGR Cooler Blanking Plate RG Colorado 2.8L Turbo Diesel TD 2012-ON		85	
BP-IS001	Isuzu 3.0 Dmax EGR Blanking Plate 2012-2013-2014-2015 Easy Use Design		85	

Code	Description	Price	Page	Note
BP-LR001	EGR Blanking Plate Suit Land Rover Discovery TD5 Series 2 Turbo Diesel		85	
BP-MB001	EGR Blanking Plate - Mitsubishi Triton 3.2L & 2.5L engine		86	
BP-MB002	EGR Blanking Plate Mitsubishi Triton MN ML 3.2 2.5 TD Pajero Challenger w Hole		86	
BP-MB003	EGR Blanking Plate Suit Mitsubishi MQ Triton & Pajero Sport 2.4L 4cyl		86	
BP-NS001	EGR Blanking Plate Nissan Patrol GU Y61 ZD30 Turbo Diesel Common Rail No Hole		86	
BP-NS002	EGR Blanking Block Plate Nissan Patrol TD42 Ti 4.2L Turbo Diesel		87	
BP-NS003	Nissan Patrol GU Y61 ZD30 3.0L Turbo Diesel Direct Injection EGR Blanking plate		87	
BP-NS004	Nissan ZD30 Patrol EGR Blanking Block off Plate 3.0L CRD / Navara 63mm Hole C/C		87	
BP-NS005	EGR Blanking Plate fit Nissan Euro3 Navara Patrol Pathfinder X-trial YD25 YD22		87	
BP-NS006	Nissan EGR Blanking Plate Patrol Navara D22 Direct Injection ZD30 3.0L DI engine		88	
BP-NS007	EGR Blanking Plate Nissan ZD30 Direct Injection DI Patrol GU Navara D22 70mm C/C		88	
BP-NS008	EGR Blanking Plate Fits Nissan Navara D22 D40 YD25 Diesel Common Rail with hole		88	
BP-NS009	Nissan Navara D40 2.5L TD Euro 5 Spec EGR Blanking Plate Stainless Steel		88	
BP-NS010	EGR Blanking plate Nissan Patrol Navara 3.0ltr CRD Common Rail Diesel with Hole		89	
BP-NS011	EGR Blanking plate Nissan Patrol Navara 3.0ltr CRD Common Rail Diesel NO Hole		89	
BP-NS012	Nissan Patrol GU ZD30 Common Rail Diesel CRD EGR Blanking Plate		89	

Code	Description	Price	Page	Note
BP-NS013	EGR BLANKING PLATE NISSAN YD25 EURO 3 SPEC ENGINE 2006 NAVARA D22 NAVARA D40		89	
BP-NS014	Nissan ZD30 Direct Injection Navara YD25 2.5L Euro 3 till 06 EGR Blanking plate		90	
BP-NS015	EGR Blanking Plate to suit Nissan NP300 Navara D23 2.3L Models		90	
BP-TA001	Toyota D4D EGR Blanking Plate 1KD-FTV 3.0L TD Hilux Prado KUN16 26 KDJ 120 150		90	
BP-TA002	EGR Blanking Plate for Toyota Landcruiser 100 78 79 105 1HZ Turbo Diesel		90	
BP-TA003	EGR Blanking Plate for Toyota D4D 1KD-FTV 3.0 TD Hilux Prado with 7mm Hole		91	
BP-TA004	6mm Hole EGR Blanking Plate Toyota D4D 1KD-FTV 3.0 Turbo Diesel Hilux Prado		91	
BP-TA005	EGR Blanking Plate Toyota Hilux Prado D4D 1KD-FTV 3.0 Turbo Diesel TD Stainless		91	
BP-TA006	EGR Blanking Plate fit Toyota D4D 1KD-FTV 3.0 TD Hilux Prado 7mm Hole New Design		91	
BP-VW004	1 x EGR Valve Blanking Plate VW TDi Seat TDi Skoda TDi Audi TDi T5 T25 Stainless		92	
BP-VW005	EGR Blanking Plate Fits VW Amarok 2.0 BiTDi Manual Auto MY11 MY12 MY13 MY14		92	
BP-YMH001&CHIP-001	Yamaha Catalytic D Plate & Cat Removal Chip 800 1200 1300 XLT GPR Waverunner R		92	
CS-HLN001	Set of 9 Holden Camber Shims Front End Wheel Alignment HQ HJ HX HZ WB LH LX UC		92	
SHIM-NS001	Limited Slip diff Shim Nissan Patrol GQ Y60 GU Y61 Rear diff lock LSD 0.7mm		93	
EGR VALVE			93	
EGRV-HLN001	Holden EGR Valve RA Rodeo 3.5L (6VE1) Jackaroo 3.5L Frontera UT 3.2L (6VD1) 6Cyl		93	

Code	Description	Price	Page	Note
ENGINE MOUNT			94	
EM-FD001	2 Front Heavy Duty Engine Mounts Ford Falcon Fairlane BA BF 2002-2008 4.0L 6cyl		94	
EM-HLN001	2 x Front Rubber Castor Rod Bush Kit Commodore VT VX VY VZ V6 V8 Caster 97-06		94	
EM-HLN002	2 Holden V6 Engine Mount Commodore VG VP VR VS VT VU VY Ute 3.8L Front Pair		94	
EM-HLN003	OEM Quality Front Engine Mount to suit Holden Astra TS AH 98-10 1.8L Automatic		94	
EM-HLN005	Holden Commodore VT VU VX VY VZ V8 GEN3 5.7L 6.0L Hydraulic Engine Mount x 2		95	
EM-MA001	RIGHT ENGINE MOUNT (Hydraulic) MAZDA 6 GG 2002-2008 OEM: GJ6G-39-060E		95	
EM-TA001(3PCS)	Rubber Exhaust Mount suit Toyota Landcruiser 40 60 75 78 80 Series # 17567-61030		95	
EM-TA001(4PCS)	4 x Toyota Landcruiser Rubber Exhaust Mounts 40 50 60 70 80 100 Series		95	
EM-TA002	Front Engine Mount Toyota Hilux 2L 3L 5L 4x4 LN106 LN111 LN130 LN167 LN172 2Pcs		96	
EM-TA003	Front Engine Mount Landcruiser HJ75 HJ60 2H Diesel Motor 12/84-90 Left / Right		96	
GEARM-TA001	Rear Engine Gearbox Mount Toyota Hilux 3L LN106 LN106R Transmission Diesel 2.8L		96	
FAN CLUTCH/VISCOUS			97	
FC-BMW001	BMW Fan Clutch 320i 323i 328i 330i 520i 528i 523i 530i Z3 X5 SUV M3 Coupe		97	
FC-NS001	Viscous Coupling Fan Clutch Nissan Patrol GQ GU Ford Maverick 4.2L Diesel TD42		97	
FC-TA001	TOYOTA Landcruiser Radiator Fan Clutch 78 105 Series HZJ78 HZJ79 HZJ105 1HZ 4.2L		97	

Code	Description	Price	Page	Note
FC-TA002	Viscous Coupling Fan Clutch Toyota Landcruiser 75 80 Series HZJ75 HZJ80 1HZ 4.2L		97	
FC-TA003	Toyota Radiator Fan Clutch Landcruiser Prado VZJ95 V6 5VZ-FE Hilux LN106 LN111		98	
FRONT STRUTS ASTRA			98	
RSA-HLN001	2 Rear Shocks Holden Astra TS Sedan & Hatchback Shock Absorber 1998 - 2004		98	
FSA-HLN001L+FSA-HL N001R	Holden Astra TS 2.2L Convertible Front Struts Shock Absorbers 01-07 Sedan Hatch		98	
FUEL CAP			99	
FUELC-SU001	Fuel Cap for Suzuki LJ50 LJ80 Sierra SJ410 SJ413 Maruti MG410 Holden Drover NB		99	
FUEL FILTER			99	
FF-MB001	Fuel Filter Daihatsu Isuzu Mazda Mitsubishi Opel Suzuki Vauxhall Hyundai MB22090		99	
FUEL PUMP			100	
DFP-HLN001	Diesel Fuel Pump Rodeo TFR55 TFS55 Holden 4JB1-T 2.8L 1990-2002 Assembly 8mm		100	
DFP-TA001	Fuel Primer Pump Toyota Hilux LN106 LN107 LN111 LN56 LN86 Diesel 2.8L 3L 4cyl		100	
DFP-TA002	Landcruiser HZJ80 Diesel Fuel Primer Pump Toyota 1HZ 80 Series 4.2L 23301-17150		100	
FP-AUDI001	Genuine Machter Universal Inline Fuel Pump Audi 80 100 M-B 220 230 60mm Petrol		100	
FP-BOSH001	Inline External Fuel Pump Group A Holden Commodore VL Statesman Falcon 220 LPH		101	
GLOW PLUG ST			101	

Code	Description	Price	Page	Note
GP-FD001	Courier PD PE PG PH 4 Glow Plugs Ford Mazda B2500 WL-T Turbo Diesel 4cyl 2.5L		101	
GP-MB001	Heater Glow Plugs Triton MK K77T L200 Pajero NL 4M40 4M40T Mitsubishi 98-04		101	
GP-NS001	Glow Plugs Set OEM Fit Nissan Patrol GQ Y60 Genuine Machter TD42 Ford DA Diesel		102	
GP-TA001	Toyota Heater Glow Plug Landcruiser HJ60 82-88 HJ75 84-88 Diesel w/2H 4.0 Diesel		102	
GP-TA002	Diesel Glow Plugs Toyota Hilux 4Runner Surf LN130 3.8L 3L 2.4L 2L-T 1989-1996		102	
GP-TA003	Landcruiser HDJ80 Glow Plugs Toyota 80 Series Turbo Diesel 1HD-T 4.2L 1990-1994		102	
HEATER HOSE			103	
HTH-NS001	Heater Hose Set Patrol GQ Y60 Maverick DA 4.2D TD42 6Cyl 1988-1997 92410-06J00		103	
HEATER VALVE TAP			103	
HVT-FD001	Heater Valve Tap Ford Falcon Fairlane EA EB ED EF EL AU 88-02 HA6315 V8 Engine		103	
HVT-FD002	Heater Valve Tap Ford EA EB ED EF EL AU DA DC DF DL NA NC NF NL 1988-2002 HV5213		103	
HVT-HLN001	Heater Valve Tap Holden Commodore V6 3.8L VX VU VY VN VP VR VS VT 4 Port 1988-04		104	
HVT-HLN002	Holden Commodore Heater Valve Tap VN VP VR VT V8 Ford Falcon XD FC FE XF ZL 4.1L		104	
HVT-HLN003	Heater Valve Tap Holden Vectra JR JS 3 Port Sedan Ute Wagon 2.0L 2.2L 2.5L 2.6L		104	
HVT-HLN004	Heater Tap Valve suit Holden VZ WL Berlina Commodore SV6 Alloytec V6 3.6L Vacuum		104	
HVT-UNI001	Heater Tap Valve Universal fit 16mm 5/8" Cable Type Inline Car Hot Rod HV4008		105	

Code	Description	Price	Page	Note
	IAC VALVE		105	
ICV-HLN001	Holden COMMODORE VR VS VT 3.6 V6 5.0 V8 Idle Air Speed Control Valve IAC ISC		105	
ICV-HLN002	Holden Idle Air Speed Control IAC ISC Valve Commodore VT VX VY VZ 5.7L V8 GEN3		105	
ICV-MB001	Idle Air Speed Control Valve For Mitsubishi Pajero NM & NP 6G74 3.5L V6 IAC IAS		106	
KS-HLN001	Pair Knock Sensor Commdore Ute Statesman 5.7L & 6.0L V8 VT VX VY VZ 10456603		106	
KS-NS001	Knock Sensor for Nissan Navara D22 Pathfinder R50 3.3L VG33E 22060-7B000		106	
KS-SR001	Knock Sensor For Subaru Impreza WRX STi G11 Liberty Outback Forester 22060-AA070		106	
KS-TA001	Toyota LandCruiser Knock Sensor FZJ75 FZJ80 92-99 4.5L 6CYL 1FZ-FE Lexus LX450		107	
STEPM-FD001	Ford FALCON AU BA BF FG VIALLE LPG Gas Converter Stepper Motor Controller		107	
	IGNITION COIL PACK		107	
IC-BMW001	New Ignition Coil Machter OEM Fit BMW E39 E46 E53 E88 3 5 7 Series X3 X5 Z3 Z4		107	
IC-BMW002	BMW Ignition Coil OEM Fit 323 325 328 330 E39 E46 E53 3 5 7 Series 12131703227		107	
IC-FD001	New Machter Ignition Coil Pack Ford Falcon BA BF Fairlane LTD XR6 Territory SX		108	
IC-FD001G	Ford Falcon Ignition Coil 6-pack BA BF Fairlane Fairmont XR6 LTD Territory SX SY		108	
IC-FD002	Set of 2 Ingition Coils Mazda 323 BJ Ford Laser KN KQ 1998-2003 ZMD 1.6L 4cyl		108	
IC-FD003	Ford Ignition Coil Pack AU2 AU3 Falcon Fairlane Fairmont Mazada Petrol 4.0L 6cyl		108	

Code	Description	Price	Page	Note
IC-HD001	Exhaust 4 Ignition Coils Honda Jazz GD GE 1.4L Civic VII 1.3L L13Z1 L13A1 LDA1		109	
IC-HD002	Ignition Coils for Honda Jazz GD GE 1.4L & Civic VII 1.3L L13A1 LDA1 Intake 4pcs		109	
IC-HD003	Honda 4 Ignition Coils Jazz II GD L15A 1.5L 4cyl 2002-2008 CM11-110 Hatchback		109	
IC-HLN001	TS AH Astra OEM Fit Holden Ignition Coil Pack 1.8L X18XE Z18XE 4cyl Petrol 98-07		109	
IC-HLN002	Holden Cruze Ignition Coil Pack JG JH Series F18D4 4Cyl 1.8L Petrol 09 onwards		110	
IC-HLN003	Ignition Coil for Rodeo TF RA Holden Jackaroo Frontera UT 6VD1 6VE1 3.2L 3.5L 1pc		110	
IC-HLN004	Ignition Coil Holden Commodore VZ Adventura Rodeo Caprice WL Statesman Crewman		110	
IC-HLN005	New Holden Commodore Ignition Coil VN VP VR VS VT VX VT Statesman WH WK Express		110	
IC-HLN006	Ignition Coil Pack Holden Barina Combo XC Series Z14XE 1.4L Petrol 4cyl 1208307		111	
IC-HLN007	New Ignition Coil Pack for Holden Viva JF F18D 1.8L 4cyl 2005-2009 96415010		111	
IC-HLN008	Ignition Module Holden Commodore VN VP VR VS VT V8 Statesman VQ VR VS 5.0L Seden		111	
IC-MA001	Mazda & Ford 6 Ignition Coils Tribute MPV LW Mercury Escape BA ZA ZB 3.0L V6		111	
IC-MA002	OEM Quality Mazda RX8 4 Ignition Coil Pack SE3P 1.3L ROTARY 13B 4cyl 2003-2012		112	
IC-MA003	Mazda & Ford Ignition Coil 323 BJ Laser KQ Premacy CP MX5 NB FFY1-18-100 2pcs		112	
IC-TA002	Toyota Ignition Coil Echo Yaris Prius Hybrid 1NZ-FE 2NZ-FE 1.3L 1.5L Petrol 4cyl		112	
IGNITION SPRAK PLUG			113	

Code	Description	Price	Page	Note
IL-HLN001	Holden Ignition Leads Spark Plug 8mm V6 Commodore VN VP VR VS VT VX VY 3.8L		113	
IL-HLN002	Holden V8 Ignition Spark Plug Leads Commodore VT VU VX VY VZ 5.7L LS1 GEN3 22mm		113	
INTERCOOLER			113	
INTERC-NS001	INTERCOOLER NISSAN PATROL GU ZD30 TURBO DIESEL 1997-2006 UPGRAD		113	
INTERC-NS002	Intercooler Upgrade For Nissan Patrol Y61 ZD30 3.0L TD Pre 07		113	
INTERC-NS003	Intercooler FOR NISSAN GU Patrol Rail 3.0L ZD30 turbo diesel 2007-2012		114	
NON RETURN VALVE			114	
CV-6MM	6mm 1/4" Alum. Alloy One Way Non-Return Check Valve Petrol Diesel Water Fuel Oil		114	
CV-8MM	8mm 5/16" Aluminium Alloy One Way Non-Return Check Valve Water Diesel Petrol Oil		114	
CV-10MM	10mm 3/8" Aluminium Alloy One Way Non-Return Check Valve Petrol Diesel Oil Water		115	
CV-12MM	ALUMINIUM 12mm 1/2" ONE WAY NON RETURN CHECK VALVE Fuel/Diesel/Water/Marine/Oil		115	
INDICATOR SWITCH STALK			115	
ISS-HLN001	HOLDEN COMMODORE VR VS VT VX INDICATOR STALK NO CRUISE BLINKER SWITCH 7 PINS		115	
ISS-HLN002	Holden VR VS VT VX1 Commodore Indicator Stalk/Switch with Cruise Control 7 ports		115	
ISS-HLN004	Indicator High Beam Stalk Switch Blinker Turn Switch Holden Rodeo TF TFR TFS		116	
ISS-TA001	1991-1997 Indicator Headlight Switch Wiper Blinker Stalk Hilux RN105 RN106 RN110		116	

Code	Description	Price	Page	Note
ISS-TA002	COMBINATION HEADLAMP SWITCH SUIT TOYOTA COROLLA ZZE122 WITHOUT FOG LAMPS 01-07		116	
NUMBER LICENSE PLATE MONT BRACKET			117	
BFMB-001	Number Licence Plate Mount Bracket for LED Driving Light Bar Black Universal		117	
BFMB-002	Number Licence Plate Mount Bracket LED Driving Light Bar Silver Stainless Steel		117	
BFMB-003	NUMBER PLATE HOLDER MOUNT BRACKET CAR LED DRIVING LIGHT BAR SPOT LICENCE FRAME		117	
NUTS			118	
NUT-TA001	Landcruiser Axle Adjusting Nut Front Hub 40 50 60 70 54mm Hilux Live 4x4 Washer		118	
NUT-HD001	Honda cable Billet Locker Nut AQUATRAX Trim REVERSE ALUM NUT F15 R12 R12X F12X		118	
NUT-SEAD001	Seadoo Steering Cable Billet Locker Nut Reverse Alum RXP RXT GTX 277000784 WAKE		118	
ST-TA001	Toyota Landcruiser Front Wheel Hub Axle Nut 54mm Socket Kit Hilux 4wd 3/8"Drive		118	
ST-TA002	Wheel Hub Nut Socket 54mm 1/2" Drive Patrol Y60, GQ, MQ , MK Maverick DA 4WD		119	
ST-TA003	Toyota Landcruiser 1/2" Drive Rear Hub Socket Axle Bearing Lock Nut 09509-25011		119	
ST-NS001	Hub Adjusting Socket Tool for Nissan Patrol GQ GU Y61 Front Wheel Bearing Nut		119	
STKIT-TA001	Toyota 54mm Axle Nut Socket Kit for Drive Hub wheel bearing Landcruiser Hilux		119	
BSA-NS001	2 Bonnet Bump Bumper Rubber Stop suits Nissan Patrol GQ Y60 Ford Maverick 88-97		120	
OIL CATCH CAN			120	

Code	Description	Price	Page	Note
OILCAN-001	Uni Pro 200 Oil Catch Can 4x4 Patrol Diesel Landcruiser Hilux Navara Turbo Vent		120	
OILCAN-001F	Pro Vent 200 Replacement Filter Element Oil Catch Can 4WD 4X4 LC5001X 3931050950		120	
OILCAN-002	Universal Oil Catch Can 4x4 Patrol Diesel Landcruiser Hilux Navara Pro 200 Turbo		121	
OILCAN-002F	Pro Turbo 200 Replacement & Washable Stainless Filter Element Oil Catch Can 4wd		121	
OILCAN-003	Patrol GQ GU Uni Pro Vent Oil Catch Can Tank Crankcase 100KW Series Paper Filter		121	
OILCAN-003SS	Oil Catch Can Crankcase Stainless Filter GQ GU Patrol Pro 100KW 2 x 3/4 inch		121	
OILCAN-004	Small 19mm Oil Catch Can Tank Crankcase Breather Vent Pro Patrol Navara Hilux		122	
OILCAN-004SS	Universal Small Oil Catch Can Tank Crankcase Pro Patrol Hilux Navara 4x4 4WD		122	
OIL CATCH TANK			122	
OCT-BLACK	Billet Aluminum Car Racing Engine Oil Catch Tank Can Reservoir Black Round Hose		122	
OCT-BLUE	1L SQUARE G-STYLE BILLET OIL CATCH TANK/CAN ALUMINUM ENGINE RESERVOIR BREATHER		122	
OCT-RED	Uni Aluminum Racing Oil Catch Can Tank Reservoir Billet RED Round Turbo Most Car		123	
OIL PRESSURE SWITCH			123	
OPS-HLN001	Holden Commodore V6 VZ VE Oil Pressure Sensor Switch 12621649 3.6L LEO LY7 Rodeo		123	
OPS-HLN002	Oil Pressure Switch Sensor Holden Commodore VT VX VY VZ VE V8 5.7 6.0 6.2		123	
OPS-HLN003	Holden Commodore VT Statesman WH WK 3.8L V6 Oil Pressure Switch Sensor 25036853		124	

Code	Description	Price	Page	Note
OPS-HLN004	Oil Rail Pressure Sensor Holden Jackaroo UBS 4JX1 ORPS 97137042 - ISUZU TD		124	
OIL PUMP			124	
OP-HLN001	Rear Main Oil Seal & Plate Housing HOLDEN STATESMANWH WK WL WM WN V8 Brand New		124	
ON / OFF ROCKER SWITCH			125	
BPS-BATT001	Toyota Push Rocker Switch LED Light Bar Prado Hilux Landcruiser 4 Runner ON OFF		125	
BPS-COMP001	Push Rocker Dash Light Switch Replacement Hilux Prado Landcruiser 4Runner 12V 3A Push Switch		125	
BPS-DRI001	Toyota Landcruiser Push Switch LED SPOT WORK DRIVING Prado 120 Hilux Highlander		125	
BPS-DRI002	Toyota Landcruiser Push Switch LED SPOT WORK DRIVING Prado 120 Hilux Highlander		125	
BPS-FOG001	Toyota Push Rocker Switch LED Light Bar Prado Hilux Landcruiser 4 Runner ON OFF		126	
BPS-FOG002	Toyota Landcruiser Push Switch LED SPOT WORK DRIVING Prado 120 Hilux Highlander Push Switch		126	
BPS-FRI001	Push Switch LED SPOT WORK DRIVING Toyota Landcruiser Prado 120 Hilux Highlander		126	
BPS-LED001	Blue LED Light BarPush Switch Toyota Landcruiser Prado Hilux Replacement Car		126	
BPS-LED002	Green LED Light Push Switch Bar Toyota Landcruiser Prado 120 Hilux Car Boat 12V		127	
BPS-LED003	LED Light Bar Push Switch Toyota Landcruiser Prado 120 Hilux 4Runner Dual Orange		127	
BPS-REAR001	Push Switch Rear Lights Toyota Landcruiser Prado 120 Hilux Car Boat Blue ON OFF		127	
BPS-REAR002	Green LED Rear Light Push Switch Toyota Landcruiser Prado 120 Hilux Laser Etched		127	

Code	Description	Price	Page	Note
BPS-REVL001	Push Switch Reverse Lights Toyota Landcruiser Prado 120 Hilux Car Boat Blue 12V Push Switch		128	
BPS-SPOT001	Laser Blue LED Spot Light On-Off Switch Landcruiser Hilux Prado Tacoma 12V		128	
BPS-SPOT002	Orange led Spot Lights Push Switch Dual Landcruiser Prado Hilux Laser Etched		128	
BPS-SPTI001	Spotties Light Push Switch Dual Blue Landcruiser Prado Hilux Laser Etched		128	
BPS-REVC001	Toyota Push Rocker Switch LED Light Bar Prado Hilux Landcruiser 4 Runner ON OFF Push Switch		129	
BPS-TRAY001	Push Switch Tray Lights Dual Blue Toyota Landcruiser Prado Hilux Laser Etched		129	
BPS-WINCH001	Push Switch Winch Power Dual Green Toyota Landcruiser Prado Hilux Laser Etched		129	
BPS-WINCH002	Push Switch Winch Power Toyota Landcruiser 75 Prado 120 Hilux FJ Cruiser ON OFF		129	
BPS-WORK001	Prado Hilux Work Lights Push Rocker Switch Blue Landcruiser Car Boat AU Stock		130	
LRS-BUMPER001	Blue LED Laser Etched Carling Type Rocker Switch 20Amp 12V Waterproofing Design		130	
LRS-AIR001	Lase Etched Rocker Switch Air Compressor RED LED ARB Carling Narva 12V 24V Boat		130	
LRS-INTER001	Blue LED Laser Etched Carling Type Rocker Switch 20Amp 12V Waterproofing Design		130	
LRS-LED001	Laser Etched Rocker Switch LED Light Bar Dual Red ARB Carling 12V 24V ON OFF AU		131	
LRS-LED002	Laser Etched Rocker Switch Dual Orange LED Light Bar Carling Style 12V 24V Boat		131	
LRS-REAR001	Laser Etched Rocker Switch REAR LIGHTS Dual Blue LED 12V 24V Boat ON OFF Backlit		131	
LRS-REAR002	Laser Etched Rocker Switch Rear Lights Dual Red ARB Carling Narva 12V 24V ON OFF		131	

Code	Description	Price	Page	Note
LRS-REAR003	Laser Rocker Switch Finger Rear Lights Blue Led Light On-Off 20A 12V Truck Car		132	
LRS-REVS001	Reverse Camera Rocker Switch Laser Etched Dual Blue LED ARB Carling 12V 24V Boat		132	
LRS-WINCH001	Laser Etched Rocker Switch Winch Power Dual Red ARB Carling 12V 24V ON OFF Boat		132	
LRS-WINCH002	Laser Etched Rocker Switch ARB Carling Dual Winch Power 12V 24V Boat ON OFF		132	
LRS-ZOMB001	Laser Etched Rocker Switch Zombie Lights 12V 24V Green Red ARB Carling ON OFF		133	
MBPS-LED001R	Mitsubishi Push Switch LED LIGHT BAR LED Red Pajero Triton Challenger Evo 3A 12V		133	
MBPS-LED002B	12V 3A Push Switch LED LIGHT BAR LED Amber BLUE on off Mitsubishi Pajero Triton		133	
MBPS-SPOT001R	Mitsubishi Push Switch SPOT LIGHTS LED Red Pajero Triton Challenger Evo 3A 12V		133	
MBPS-SPOT002B	Mitsubishi Push Switch SPOT LIGHTS LED Blue Pajero Triton Challenger Evo 3A 12V		134	
NSPS-AIR001Y	Nissan Push Switch AIR COMP Yellow Pathfinder Navara D40 Patrol X-Trail 3A 12V		134	
NSPS-DRIV001Y	Nissan Push Switch DRIVING LIGHTS Yellow Pathfinder Navara D40 Patrol Y62 3A 12V		134	
NSPS-LED001Y	Push Switch 12V LED LIGHTS ON OFF YELLOW Nissan Patrol Pathfinder Navara 12V 3A		134	
NSPS-REAR001Y	Nissan Push Switch REAR LIGHT Yellow Pathfinder Navara D40 Patrol X-Trail 3A 12V		135	
NSPS-REVS001Y	Nissan Push Switch REVERSE LIGHTS Yellow Pathfinder Navara D40 Patrol XTrail 12V		135	
NSPS-SPOT001Y	Nissan Push Switch SPOT LIGHT Yellow Pathfinder Navara D40 Patrol X-Trail 3A 12V		135	
PS-AIR001	Push Switch AIR COMP Toyota Prado 150 200 Landcruiser Hilux RAV4 ON OFF 12V Blue		135	

Code	Description	Price	Page	Note
PS-CAM001	Push Switch Toyota Prado 150 200 Landcruiser 200 RAV4 LED Light Bar 12V ON OFF rocker switch		136	
PS-COMP001	Push Switch Compressor Toyota Prado 150 200 Landcruiser RAV4 Green Red ON OFF		136	
PS-DRI001	Push Switch Driving Lights Toyota Landcruiser Prado 150 200 RAV4 Green Red 12V		136	
PS-DRI002	Push Switch Driving Lights Toyota Landcruiser Prado 150 200 RAV4 Blue ON OFF 12V		136	
PS-DRI003	Push Switch Driving Lights Toyota Landcruiser RAV4 Prado 150 200 Green ON OFF		137	
PS-DRI004	Push Switch Driving Lights Toyota Landcruiser 200 RAV4 Prado 150 200 Orange 12V		137	
PS-FOG001	Push Switch Toyota Prado 150 200 Landcruiser 200 RAV4 LED Light Bar 12V ON OFF rocker switch		137	
PS-FRID001	LED Light Bar Push Rocker Switch Toyota Hilux RAV4 Landcruiser Prado 150 12V 3A rocker switch		137	
PS-LED001	LED Light Bar Push Rocker Switch Toyota Hilux RAV4 Landcruiser Prado 150 12V 3A rocker switch		138	
PS-LED002	Push Switch LED Light Bar Toyota Landcruiser Prado 150 200 Hilux ON OFF Green rocker switch		138	
PS-LED003	Push Switch LED Light Bar Toyota Landcruiser Prado 150 200 RAV4 Green Red ON OFF		138	
PS-LED004	Push Switch LED Light Bar Toyota Prado 150 200 Landcruiser RAV4 Red 12V ON OFF		138	
PS-LED005	Push Switch Blue LED Light Bar RAV4 Landcruiser 200 Prado 150 200 12V 3A ON OFF		139	
PS-REAR001	Push Switch Rear Lights Toyota Landcruiser Prado 150 200 RAV4 Blue 12V ON OFF		139	
PS-REVS001	Push Switch Reverse Lights Toyota Landcruiser Prado 150 200 RAV4 12V Green Red		139	
PS-SPOT001	Push Switch Spot Lights Toyota Landcruiser Prado 150 200 RAV4 Blue 12V ON OFF		139	

Code	Description	Price	Page	Note
PS-SPOT002	Push Switch Spot Lights Toyota Prado 150 200 Landcruiser RAV4 Green 12V ON OFF		140	
PS-SPTS001	Push Switch Spotties Toyota Landcruiser Prado 150 200 RAV4 Green Red 12V ON OFF		140	
PS-SPTS002	Push Switch Spotties Toyota Prado 150 200 RAV4 Landcruiser ON-OFF Laser Etched		140	
PS-TRAY001	Push Switch Tray Lights Toyota Landcruiser Prado 150 200 RAV4 Green Red ON OFF		140	
PS-USB001	Push Switch USB Blue Toyota Replacement Hilux RAV4 Landcruiser Prado 150 200 12V		141	
PS-WORK001	Push Switch Work Lights Toyota Landcruiser 200 Prado 150 Hilux Blue 12V ON OFF		141	
RS-AUXI001	ARB ROCKER SWITCH AUX BATTERY CARLING NARVA DUAL BLUE LED BACKLIT ON OFF 12V 24V		141	
RS-AUXY001	ARB AUXILLARY BATTERY ROCKER ON/OFF SWITCH BLUE LED BACKLIT 4X4 Car Boat 12V 24V		141	
RS-BUNNY001	BUNNY BURNERS NARVA ARB CARLING ROCKER SWITCH LIGHTS BLUE LED ON/OFF Car Boat		142	
RS-COMP001	ARB ROCKER SWITCHES COMPRESSOR LIGHTS DUAL BLUE LED BAR Car 12V ON OFF CARLING		142	
RS-DRIV001	ARB CARLING ROCKER SWITCH DRIVING LIGHTS DUAL BLUE LED ON OFF Car Boat 12V 24V		142	
RS-DRIV001RED	ARB ROCKER SWITCH CARLING NARVA DRIVING LIGHT DUAL RED BACKLIT ON OFF 12V 24V		142	
RS-ENFAN001	ARB CARLING NARVA ROCKER SWITCH ENGINE FAN DUAL BLUE LED ON OFF Car Boat 12V 24V		143	
RS-FOG001	ARB ROCKER SWITCH FOG LIGHTS NARVA CARLING DUAL BLUE LED BACKLIT ON/OFF 12V 24V		143	
RS-FRID001	ARB STYLE LED BACKLIT ROCKER SWITCH BLUE LED CARLING FRIDGE Toggle Switch 12V		143	
RS-LED001	ARB Carling Narva Rocker Switch LED LIGHT BAR Dual BLUE LED 12V 24V Car Boat		143	

Code	Description	Price	Page	Note
RS-LED001GREEN	ARB ROCKER SWITCHES LED LIGHT BAR CARLING DUAL GREEN LED ON OFF Car Boat 12V 24V		144	
RS-LED002	LED LIGHT BAR CARLING NARVA ARB ROCKER SWITCH DUAL RED ON/OFF 12V 24V Car Boat		144	
RS-LEFT001	ARB CARLING ROCKER SWITCH LEFT SIDE LIGHTS DUAL BLUE LED ON OFF Car Boat 12V 24V		144	
RS-MON001	Winch In/Out Momentary Rocker Switch ARB Lightforce Nissan GU GQ 80 Hilux Jeep		144	
RS-MUSIC001	Rocker Switch Music ARB Carling Narva Dual Blue LED 12V 24V ON OFF Car Boat		145	
RS-NLED001	Laser Etched LED Light Bar Rocker Switches Backlit DUAL BLUE LED 12V 20A ON/OFF		145	
RS-NSPOT001	LASER ETCHED SPOT LIGHT ROCKER SWITCH WORK LIGHT BAR 4WD UTE 12V 24V CARLING		145	
RS-OFFROAD001	ARB CARLING ROCKER SWITCH OFF ROAD LIGHTS DUAL BLUE LED ON OFF Car Boat 12V 24V		145	
RS-ROOF001	ARB ROCKER SWITCH ROOF LIGHTS CARLING NARVA DUAL BLUE LED BACKLIT ON/OFF 12V 24V		146	
RS-REAR001	ARB Carling Narva Rocker Switch REAR LIGHT Blue LED 4x4 4WD 12V 24V Car Boat		146	
RS-REAR001RED	ARB CARLING NARVA ROCKER SWITCH REAR LIGHTS DUAL RED LED ON OFF Car Boat 12V 24V		146	
RS-REAROFF001	ARB CARLING ROCKER SWITCH REAR ROOF LIGHT DUAL BLUE LED BACKLIT ON OFF 12V 24V		146	
RS-REVS001	Rocker Switch ARB Carling Narva Dual Blue Led Reverse Lights Car Boat 12V ON OFF		147	
RS-REVS002	ARB ROCKER SWITCH REVERSE CAMERA CARLING NARVA DUAL BLUE LED BACKLIT ON/OFF 12V		147	
RS-RIGHT001	ARB ROCKER SWITCH RIGHT SIDE LIGHTS CARLING DUAL BLUE LED BACKLIT ON OFF 12V 24V		147	
RS-SPOT001ORA	ARB CARLING ROCKER SWITCHES SPOT LIGHTS DUAL ORANGE LED ON OFF Car Boat 12V 24V		147	

Code	Description	Price	Page	Note
RS-SPOTTIE001	ARB ROCKER SWITCH SPOTTIES CARLING NARVA DUAL BLUE LED BACKLIT ON OFF 12V 24V		148	
RS-SPOT001	ARB Rocker Switch SPOT LIGHTS Narva Carling ON/OFF Blue LED 12V 24V 4WD Car Boat		148	
RS-TRAY001	ARB Rocker Switch Tray Lights Carling Narva 12V 24V Dual Blue Backlit ON/OFF		148	
RS-WINCH001	WINCH ISOLATOR NARVA ARB CARLING ROCKER SWITCH LIGHTS BLUE LED ON/OFF Car Boat		148	
RS-WINPOWER	ARB CARLING NARVA ROCKER SWITCH WINCH POWER DUAL BLUE LED ON OFF Car Boat 12/24V		149	
RS-ZOMB001	ARB Rocker Switch Zombie Lights Carling Narva ON OFF Dual Blue Backlit 12V 24V		149	
USB-ST001	Blue LED Rocker Switch USB Charger Panel Dual 2 Port Carling Socket Car 5V 3.1A		149	
USB-TA001	USB Charger Switch Dual Blue Prado 120 Hilux LC 75-100 4Runner FJ Cruiser Tacoma		149	
USB-TA002	Dual USB Charger Switch Toyota Prado 120 Hilux LC75-100 FJ Cruiser Highlander		150	
PITMAN IDLER ARM			150	
FSKIT-TA001	Hilux 4x4 LN165 LN166 LN170 LN192 Toyota Ball Joint Tie Rod End Idler Pitman Arm		150	
PA-TA001	Hilux IFS 4X4 Pitman Arm Toyota LN167 LN172 RZN169 RZN174 1997-2005 Right Hand		150	
PIARM-TA001	Steering Idler Pitman Arm Toyota Hilux LN167 LN172 KZN165 RZN169 VZN167 4x4 IFS		151	
SIA-TA001	Idler Arm Steering Joint Toyota IFS Hilux LN167 LN172 KZN165 RZN169 VZN167 4WD		151	
POWER STEERING KIT			151	
PSK-TA001	Power Steering Box Seal Kit Toyota Landcruiser 80 Series FJ80 FZJ80 HDJ80 HZJ80		151	

Code	Description	Price	Page	Note
POWER STEERING PUMP			152	
PSP-HD001	Honda Accord Euro Power Steering Pump 03-07 2.4L 4 Cyl K24A Accord US 06-08		152	
PSP-HLN001	Power Steering Pump Holden Commodore 5.7 LITRE Gen 3 LS1 V8 VT VX VU VY WH WK WL		152	
PSP-HLN002	HOLDEN COMMODORE V8 VG VQ VN VP VR VS POWER STEERING PUMP BRAND NEW		152	
PSP-TA002	Fit Toyota Land Cruiser 80 Series HZJ75 4.2 1HD 1HDFT Diesel Power Steering Pump		152	
POWER STEERING RACK			153	
PSR-TA001	Toyota Hilux KUN26 GGN25 4WD SR5 Power Steering Rack Pinion w/ Tie Rod Ends		153	
PSR-TA002	POWER STEERING RACK FOR TOYOTA LANDCRUISER PRADO KZJ95 VZJ95 RZJ95 90 95 SERIES		153	
PSR-TA001-TRE	Tie Rod Ends Toyota Hilux KUN26 GGN25 KUN25 TGN26 4x4 Outer Front Left & Right		153	
POWER STEERING RACK BOOT			154	
PSRB-FD001	Power Steering Rack Rubber Boot Holden Commodore VT VX VY VZ WH WK WL 97-04 All		154	
RADIATOR OVERFLOW BOTTLE			154	
ROB-SU001	Overflow Bottle for Suzuki Sierra SJ410 SJ40 SJ413 SJ50 SJ80 SJ70 Maruti MG410		154	
RADIATOR			155	
RAD-MA001	Ford Courier Mazda Bravo Heavy Duty Radiator 1996-2006 Manual 34mm thick core		155	
RAD-MB001	MK Triton Radiator MANUAL Mitsubishi V6 3.0L 6Cyl 1996-2006 Aluminium Core		155	

Code	Description	Price	Page	Note
RAD-MB002	MK Triton Radiator Auto Mitsubishi 96-06 6Cyl 3.0L V6 Aluminium Alloy Heavy Duty		155	
RADIATOR FAN			156	
FB-NS001	Radiator Fan Blade Navara D21 D22 Engine Cooling Terrano II R20 TD27 TD27Ti 2.7L		156	
FB-NS002	Navara D21 TD27 Engine Fan Blade Electric Radiator Diesel 1995-02/1997 cooling		156	
FB-NS003	OEM QUALITY ENGINE FAN BLADE FOR NISSAN PATROL COMMON RAIL ZD30 3.0L 03/07-2014		156	
FB-NS004	FAN BLADE FIT NISSAN PATROL GQ Y60 TD42 4.2 DIESEL		156	
FB-NS005	Nissan Engine Cooling Fan Blade Patrol GQ Y60 Maverick DA 1988-99 TD42 Diesel		157	
FB-TA001	Fan Blade suit Landcruiser 6cyl 4.2L 1HZ 1HD-FT 1HD-T & 5cyl 3.5L 1PZ Engine		157	
FB-TA002	Toyota Dyna Truck Engine Radiator Fan Blade LY61 Hilux 4 Runner Diesel		157	
FB-TA003	Engine Fan Blade Toyota Hilux Surf KZN130R 1993-1995 4cyl 1KZ-TE 3.0L Diesel		157	
REMOTE KEY SHELL			158	
RBC-TA001L&RBC-TA001R	2 Toyota Rear Disc Brake Caliper Landcruiser VDJ76 VDJ78 VDJ79 V8 Left Right NEW		158	
RBC-TA002L+RBC-TA002R	2 Front Brake Calipers Toyota Hilux LN106 LN107 LN111 RN105 RN106 RN110 RN130		158	
RKS-FD002	Remote Key Shell Case Ford 4 Button Falcon BA BF Territory SX XR6 XR8 FPV		158	
SNORKEL KIT			159	
SNOK-NS003	Nissan Patrol GQ Snorkel Kit Y60 Ford Maverick Diesel TD42 TB42 RB30 4WD 88-97		159	

Code	Description	Price	Page	Note
SPARK PLUG			159	
SP-FD001	Ford Falcon Spark Plugs For BA XR6 Territory SX 4.0L Petrol 6cyl AGSP32Z 6pcs		159	
SP-FD002	Spark Plugs Ford Falcon BF FG 4.0L LPG Territory SY 0.7mm AGSP22YE07 Pack of 6		159	
STARTER MOTOR			160	
SMOTOR-HLN001	Commodore Starter Motor Holden V8 LS1 GEN3 GEN4 VT VX VY VZ VE SS 5.7L 99 - 04		160	
SMOTOR-HLN002	Starter Motor Fits Holden Rodeo TF 4WD Diesel 2.8L 4JB1T & 2.5L 4JA1 1988-2004		160	
SMOTOR-HLN004	Starter Motor Holden Adventra Commodore VZ VE 3.6L Petrol V6 HF Statesman WL WM		160	
SMOTOR-LR001	Starter motor for Land Rover Discovery V8 3.5L 3.9L 4.0L Petrol Series 1 2 3		160	
SMOTOR-MA001	Starter Motor for Ford Courier PD PE PG PH Ranger PJ PK Mazda Bravo B2500 WL WLT		161	
SMOTOR-NS001	Nissan Patrol Starter Motor GQ GU TD42 TD45 TD48 4.2L 4.5L 4.8L Diesel 88-07		161	
SMOTOR-NS002	Nissan Starter Motor Navara D21 D22 2.5L 2.7L 3.0L 3.2L TD24 TD25 TD27 ZD30 QD32		161	
SMOTOR-TA001	Toyota Starter Motor suit Hilux KUN16 KUN26 D4D Prado KDJ120 1KD-FTV 3.0L Diese		161	
SMOTOR-TA002	Toyota Landcruiser Starter Motor HJ47 HJ60 HJ61 HJ75 Eng 2H 12HT 4.0L Diesel		162	
SMOTOR-TA003	TOYOTA Hilux Starter Motor LN86 LN106 LN106R LN107 LN111 L 2L 3L 5L Diesel		162	
SMOTOR-TA006	Starter Motor to fit Toyota Landcruiser HZJ80 HZJ79 HZJ78 HZJ75 with 4.2L diesel		162	
STRUT MOUNTS			163	

Code	Description	Price	Page	Note
SM-FD001	FRONT SUSPENSION STRUT TOP MOUNT + BEARING KIT VW Golf MK III FORD Galaxy 95-06		163	
SM-HLN001	Strut Mount & Bearing Kit Holden Crewman Ute VU VY VZ Commodore Top Rubber Bush		163	
SM-HLN001B	Holden Strut Top Mount Bearing Commodore VR VS VT VU VX VY VE Statesman WH		163	
TENSIONER			164	
DB-NS001	Engine Drive Belt for Nissan Patrol GU Y61 ZD30DDT 3L Diesel Navara D22 D40 4cyl		164	
IP-HLN001	IDLER PULLEY HOLDEN COMMODORE SMOOTH VN VP VR VX VY WH WK V6 3.8L 88-04 38005		164	
IP-HLN002	Holden Commodore VS VT VX VY 3.8L V6 Gates Tensioner Pulley 38006		164	
IP-HLN003	Holden Drive Belt Idler Pulley VS VT VX VU VY Commodore V6 Calais Berlina 38009		164	
IP-HLN004	Ford Falcon Idler Pulley AU BA BF EF EL AU1 2 Drive Belt Lower Petrol Ute 38015		165	
TN-FD002	Ford Drive Belt Tensioner Falcon AU 1/2/3 EF EL Fairlane NF NL DF DL 4.0L 6cyl		165	
TN-MB001	Pajero Drive Belt Tensioner Mitsubishi NM NP NS NT NW Petrol V6 3.5L 2000-2012		165	
TB-NS001	GU Patrol Drive Belt Tensioner for Nissan 3.0TDi ZD30 00-07 4cyl LWB Wagon 5Dr		165	
TN-HLN001	New OEM Holden Commodore Drive Belt Tensioner Pulley VS VT VX VY V6 3.8L 95-04		166	
TN-HLN002	Holden Commodore Drive Belt A/C Tensioner VT VX VY VZ VE V8 5.7 LS1 GEN3 Pulley		166	
TN-HLN004	Drive Belt Tensioner Holden Commodore VE VT VX VY VZ V8 LS1 Gen3 Idler Tensioner		166	
TN-NS001	Patrol GU Drive Fan Belt Tensioner for Nissan ZD30 Turbo Diesel 00-07 3.0L 4cyl		166	

Code	Description	Price	Page	Note
TN-NS002	Patrol Drive Belt Tensioner for GU Y61 ZD30DDTi ZD30DDT Diesel 3.0L 2000-2014		167	
TN-NS004	Patrol GU Drive Belt Tensioner Assembly Nissan 2007-2014 4cyl ZD30DDTi 3.0L CRD		167	
THERMOSTAT			167	
THE-HLN001	HOLDEN THERMOSTAT 88-04 COMMODORE 3.8L V6 VN VP VQ VR VS VT VX VY STATESMAN WH		167	
GST-002	OPEN BASE GASKET 4150 HOLLEY SQUARE BORE 4 BARRY GRANT & EDELBROCK CARBS		167	
GST-003	THERMOSTAT GASKET HOLDEN COMMODORE VN VP VQ VR VS VT VX VY 3.8L V6 1988-2004		168	
GST-HLN001	INLET/INTAKE MANIFOLD GASKET-HOLDEN COMMODORE VZ,VE,VF V6 3.6L ALLOYTEC 04-4/13		168	
THROTTLE POSITION SENSOR			168	
TPS-HLN001	Throttle Position Sensor switch Holden Commodore VN VP VR VS VT 17106682 TPS		168	
TPS-HLN002	Throttle Position Sensor 3 Pins For Holden Commodore V6 VS VT VU VX VY 17106681		168	
TPS-HLN003	Holden LS1 Commodore 5.7L GEN 3 VT VX VY HSV Throttle Position Sensor		169	
TPS-HLN004	TPS Throttle Position Sensor fit Holden Jackaroo 4JX1 3.0L Diesel 98-02 97372851		169	
TILE ROD END			169	
SKAPB-TA001	Steering Knuckle Arm Pivot Ball Hilux RN36 RN46 YN60 YN63 YN65 Drop Boomerang		169	
TR-HLN001	Holden TIE ROD END steering adjuster Bar HQ HJ HX HZ WB NEW PAIR AU Stock		169	
TRE-TA001	Landcruiser BJ40 BJ42 FJ40 FJ45 HJ45 HJ47 Tie Rod Relay End Kit 4X4 LHD 5pcs		170	

Code	Description	Price	Page	Note
TRE-TA003	Landcruiser HJ75 FJ70 FJ73 BJ70 Tie Rod End Kit Toyota 70 75 Series Steering RHD		170	
TRE-TA005	Steering Joint Tie Rod Relay End Kit Toyota Landcruiser 70 75 HZJ75 FZJ75 FJ75		170	
TIMING CHAIN KIT			171	
TCKIT-HLN001	PREMIUM Holden Commodore VZ VE VF Alloytec LY7 LE0 LLT 3.6L V6 Timing Chain Kit		171	
TOWBAR			171	
TOWBAR-001	2" TOWBAR TONGUE BALL MOUNT HITCH TOW BAR TOWING 5000LBS HAYMAN REESE TYPE TJM		171	
TOWBAR-002	2" DROP 3/4" RISE TOWBAR TONGUE BALL HITCH SUIT HAYMAN REECE, ARB TJM 5000LBS		171	
TOWBAR-003	HEAVY DUTY 4000KG EXTREME ADJUSTABLE TOW BALL MOUNT TOWBAR TONGUE HITCH 4TON		172	
TOWBAR-004	2" X 2" ADJUSTABLE TOWBAR TONGUE BALL MOUNT HITCH FOR SQUARE RECEIVERS		172	
TOWBAR-005	Multi Use Dual Towbar Tow Bar Ball Mount Tongue Hitch Trailer 4WD Car Bike Rack		172	
TOWBAR-006	Recovery Hitch Tow Bar Receiver 5 Tonne Rating With Bow Shackle Off Road 4WD 4X4		172	
Towbar-HB	CHROME TOW BALL 50MM - 3500KG - TRAILER PART HITCH TOWBALL 4WD		173	
Towbar-HP	16MM 5/8" HITCH PIN & R CLIP TOWBAR TOWING 4WD TRAILER BALL MOUNT RATED 3500KG		173	
TURBO BOOST CONTROLLER			173	
TBC-BLACK	Nissan Mitsubishi Turbo Black Boost Controller Incabin adjustable + fitting Kit		173	
TBC-BLUE	Adjustable Blue Turbo Boost Controller Incabin Fitting Kit BMW Benz Volkswagen		173	

Code	Description	Price	Page	Note
VALVE-001	Dawes Valve Needle valve GU Patrol ZD30 MANUAL BOOST CONTROL Heavy Duty Spring		174	
UNI JOINT SET			174	
UJ-FD001	UNIVERSAL U-JOINT FOR MOST LAND ROVER DISCOVERY 91 ON DRIVE SHAFT FRONT OR REAR		174	
UJ-MB001	One Uni. Joint L200 L300 Pajero Triton Starion Starwagon Triton MA MD MB SE SF		174	
UJ-SU001	Universal Joint Suzuki Jimny Sierra 1.0/1.3 Maruti 1.0 Drover (11/84-99) Ø 25 mm		175	
UJ-TA001	Uni Universal Joint Toyota Landcruiser 80 Series HJ60 HDJ80 FJ40/43/45 80-97		175	
UJ-TA002	Hilux KUN26R KZN165R LN106R 107R 111R 167R RUJ2109 DYNA 150 Universal Joint		175	
UJ-TA003	TOYOTA LANDCRUISER UNIVERSAL JOINT DYNA 200,300,400 series RUJ 2041 32mm od		175	
VALVE COVER GASKET			176	
VCG-HLN001	HOLDEN ROCKER COVER GASKETS COMMODORE V6 3.8L Calais Caprice Monaro Statesman		176	
WATER PUMP			176	
WP-BMW001	Coolant Water Pump BMW E36 E46 E30 E34 316i 318i Z3 Heavy Duty Compact Cabrio		176	
WP-FD001	Ford & Mazda Water Pump Courier PD PE PG PH Bravo B2500 WL Diesel Ute 8ALA15100		176	
WP-FD004	Ford Transit Water Pump VH VJ VM D4FA VAN UTE 4cyl 2.4L 2000-2010 Turbo Diesel		177	
WP-HLN001	Holden 3.8L V6 Water Pump +Gasket Commodore VN VP VR VS VT VU VX VY 1988-7/2004		177	
WP-HLN002	Holden Commodore Water Pump Berlina Calais Statesman V6 VZ VE WL WM 3.6L +Gasket		177	

Code	Description	Price	Page	Note
WP-HLN003	GTO Firebird Water Pump for Chevrolet Corvette Camaro Pontiac 5.7L 6.0L		177	
WP-HLN003GST	Water Pump Gaskets Kit for Camaro Corvette GTO Firebird LS1 LS6 5.7L AW5081		178	
WP-HLN004	Engine Water Pump Holden Jackaroo UBS55 1989-1992 4cyl 4JB1-T 2.8L Turbo Diesel		178	
WP-HLN005	Jackaroo & Rodeo Water Pump Holden UBS17 TFR17 TFS17 GWIS-31A 2.6L Petrol 4cyl		178	
WP-MA001	Water Pump Mazda 323 BF BG MX-5 NA B6-T 1.6L Turbo 1.8L BP-DOHC 1.8L Petrol 16V		178	
WP-MB001	Mitsubishi Water Pump Magna TR TS 6cyl 6G72-S2 3.0L Petrol V6 Engine 1993-1996		179	
WP-MB002	Mitsubishi Water Pump Pajero NJ NK NL 2.8 4M40 4M40T 4M41 Triton MK 1993-2006		179	
WP-MB004	Mitsubishi Water Pump Pajero NA -NG Diesel 4D55 4D56 Triton ME MF MG MH MJ 2.3L		179	
WP-MB005	Water Pump Pajero NA-NH 83-93 Triton ME-MJ 86-96 Diesel 2.6L 4cyl Mitsubishi		179	
WP-NS002	Water Pump for Nissan Patrol GQ Y60 TB42S TB42E Ford Maverick 4.2L Petrol 88-97		180	
WP-NS003	Water Pump for Nissan Patrol TD42 4.2L Diesel GQ GU Y60 Y61 Safari Turbo Ford DA		180	
WPFC-NS01	Water Pump + Fan Clutch fit Nissan Patrol GU 2000-1/07 4cyl ZD30 3.0TDi Diesel		180	
WP-TA004	Toyota Engine Water Pump Hilux LN86 LN106 LN107 LN111 LN147 LN167 Ute 3L Diesel		180	
WP-TA006	Landcruiser HDJ78 HDJ79 HDJ80 Water Pump Toyota Turbo Diesel 6cyl 4.2L 1HD-FTE		181	
WP-TA007	OEM Quality Water Pump Toyota Landcruiser HJ47 HJ60 HJ61 HJ75 4.0L 6cyl Diesel		181	
WPKIT-TA006	Timing Belt Tensioner Water Pump Kit Landcruiser HZJ75 HZJ80 1HZ 4.2L Diesel		181	

Code	Description	Price	Page	Note
WINDOW REGULATOR			182	
WR-AU001L	Power Window Regulator Audi A4 S4 Front Left LH Electric No Motor 02~08 8E B6		182	
WR-AU001R	Audi A4 S4 Window Regulator 8E B6 8E0837462B Front Right Side 02-08		182	
WR-BMW001L	Window Regulator BMW 3 Series E46 Front Left Hand 316i 318i 320i 323i 328i 330i		182	
WR-BMW001R	BMW Window Regulator 3 Series 318i 320i 323i 328i Sedan F&R 8/98 - 5/05 Drive		182	
WR-BMW002L	Window Regulator BMW 3 Series E46 318i 320i 323i 325i 328i 330i Left Hand Rear		183	
WR-BMW002R	BMW 3 Series Window Regulator E46 Rear Right Side 316i 318i 320i 323i 325i 328i		183	
WINDOW SWITCH			183	
WS-FD001	Ford AU Falcon Fairmont Fairlane Single Power Window Switch 7 Pin Type 1998-2002		183	
WS-HLN001	Holden Commodore VT VX Electric Power Window Master Control Switch 1999-2002		183	
WS-HLN002	Holden Commodore VY VZ Power Master Window Switch 13 Pins 92111628		184	
WS-HLN003	Power Window Master Switch 2 Button fits Holden Commodore VY VZ 02-06 Ute Black		184	
WS-TA001	Electric Main Window Switch Front Right Toyota Landcruiser 80 Series 1990-1998		184	
WS-TA003	TOYOTA 70 80 Landcruiser Camry DV10 Prado 95 Hiace Power Single Window Switch		184	
WINDSCREEN WASHER PUMP MOTOR			185	
WWP-BMW01	Windscreen Washer Pump BMW 3/5/X/Z Series E36 E46 E53 E83 E85 E86 F11 F25 12V		185	

Code	Description	Price	Page	Note
WWP-FD01	Windscreen Washer Pump For Ford Falcon BA/BF/FG Front 12V 09/2002-2013		185	
WWP-HLN02	Windscreen Wiper Washer Bottle Pump Motor KB TF Holden Rodeo 08/1980 - 02/2003		185	
WWP-NS01	Wiper Washer Pump Windscreen fit Nissan Patrol GQ Y60 Ford Maverick DA Petrol		185	
WWP-NS02	Windscreen Wiper Washer Pump for Patrol GU Y61 97-04 4.2TD 2.8TD Front Pair Set		186	
WWP-TA001	Brand New Wiper Washer Pump Toyota Landcruiser FJ40 BJ40 BJ42 FJ45 HJ47 FJ55		186	
WWP-UNI01	Windscreen Window Washer Pump Spray Motor 12 V For Most Japanese Cars		186	
WWP-UNI02	Windscreen / Windshield Washer Bottle Kit Universal 12V Switch Wiring Jets		186	
WINDSCREEN WIPER BLADES			187	
WWB-HLN001	Commodore Berlina Calais Windscreen Wiper Blade Frameless Holden VE *Express*		187	
OTHER			187	
BRKIT-TA001	Toyota Nissan Mitsubishi Breather Kit 4 Port Diff Hilux Landcruiser Patrol Triton		187	
CVV-BMW001	Crankcase Vent Valve BMW E36 E46 316i 318i 318ti 318is 518i Z3 11157501567 PCV		187	
EB-FD001	EXTRACTOR BOLTS 3/8" 16pcs FORD CLEVELAND WINDSOR XR XT XW XY 302 351 Silver		188	
EDIS-TA001	Electronic Distributor Fit Toyota Land Cruiser FJ40-FJ80 2F 3F 4.2L 4.0L		188	
LIFTER-CR001	LS7 Roller Hydraulic Valve Lifter S1 LS2 LS3 L76 L77 L98 Commodore GM Heavy Duty		188	



Price : (AUD)

AIH-MA001 / Mazda 323 1.8L 2.0L Astina 98-03 BJ Air Cleaner Intake Hose & Ford KN KQ Laser

Dimension:385*150*110mm

Weight:0.70kg



Price : (AUD)

AIH-MA002 / Air Cleaner Intake Hose Mazda 323 1.6L Astina BJ 98-03 & Ford KN KQ Laser

Dimension:/

Weight:/



Price : (AUD)

AIH-TA001 / Air Cleaner Intake Hose Landcruiser HZJ80 HZJ81 1HZ 4.2L Diesel 80 Series

Dimension:310*155*120mm

Weight:0.65kg



Price : (AUD)

AIH-TA002 / Air Intake Hose Landcruiser 1FZ 4.5L FZJ75 FZJ80 8/1992-1998 75 80 Series Petrol

Dimension:420*140*120mm

Weight:0.75kg



Price : (AUD)

**AIH-TA003 / Air Intake Hose Hilux LN106 LN107 LN111
LN130 LN85 LN86 1988-97 2L 3L Diesel**

Dimension:460*120*80mm

Weight:1kg



Price : (AUD)

**AIH-TA004 / Air Intake Hose Hilux 1997 to 8/2000 LN147
LN167 LN172 5L 3.0L Diesel Engine Ute**

Dimension:265*110*110mm

Weight:0.50kg



Price : (AUD)

**AIH-TA008 / Air Intake Hose Toyota Camry SXV10
1993-1997 5S-FE 2.2L 2164cc Engine**

Dimension:385*150*100mm

Weight:0.65kg



Price : (AUD)

**AIH-TA009 / Engine Air Cleaner Intake Hose Hilux 2L
Diesel LN55 LN56 LN60 LN61 LN65 1983-89**

Dimension:480*140*100mm

Weight:0.75kg



Price : (AUD)

AIH-TA010 / Air Intake Hose Toyota Landcruiser HZJ70, 73, 75, 78, 79 4.2L 1HZ Diesel 1990-2007

Dimension: /
Weight: /



Price : (AUD)

AIH-VW001 / Vw amarok high performance air intake hose

Dimension: 570*230*160mm
Weight: 1.7kg



Price : (AUD)

APS-PSI120 / 90-120PSI Air Compressor Pump Pressure Switch

Dimension: 140*85*85mm
Weight: 0.2kg



Price : (AUD)

APS-PSI175 / 145-175 PSI Air Compressor Pump Pressure Switch

Dimension: 140*85*85mm
Weight: 0.2kg



Price : (AUD)

AHORN-001 / 150db 12V Super Loud Dual Trumpet Air Horn Horns For Truck Mega Train Chrome

Dimension:/
Weight: /



Price : (AUD)

AHORN-002 / 150db Truck Mega Train Single Trumpet Air Horn Kit w DC 12V Compressor

Dimension: /
Weight: /



Price : (AUD)

RAHORN-001 / Back Up Horn Reversing Alarm / Reverse Siren Beeper Buzzer Warning Alert 12 Volt

Dimension: /
Weight: /

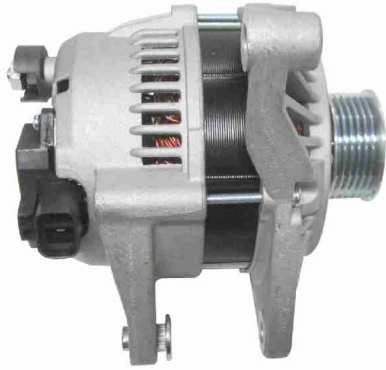

Price : (AUD)

ALTER-HLN001 / Alternator fits Holden Commodore V6 VS VT VU VX VY 3.8L Sedan Wagon Ute

Dimension:260*180*190mm

Weight:5.42kg



Price : (AUD)

ALTER-HLN002 / NEW ALTERNATOR TO FIT HOLDEN COMMODORE 5.0L V8 VL VN VR VS VG VQ

Dimension:260*180*190mm

Weight:5.32kg



Price : (AUD)

ALTER-HLN004 / Alternator Holden Commodore V8 HSV VZ VE V8 GEN4 GEN5 12V 140A 2 Pins Plug 6.0L

Dimension:/

Weight:/



Price : (AUD)

ALTER-HLN005 / Alternator Fit Holden Commodore V8 GEN 3 LS1 VT VX VY VU WH WK WL 5.7L HSV 140A

Dimension:/

Weight:/



Price : (AUD)

ALTER-NS001 / New 80Amp Alternator to fit Nissan Patrol GQ GU 4.2L Diesel (TD42) 1988 to 2003

Dimension:280*240*195mm

Weight:6.95kg



Price : (AUD)

ALTER-TA001 / New Alternator to fit Toyota Landcruiser 1HZ 4.2L Diesel 80 Series & 100 Series

Dimension:230*195*165mm

Weight:6.5kg



Price : (AUD)

ALTER-TA002 / Alternator to fit TOYOTA HiLux D4D KUN16R KUN26R Turbo Diesel 1KD-FTV 3.0L 05-14

Dimension:265*195*185mm

Weight:6.15kg



Price : (AUD)

ALTER-TA003 / Alternator - Toyota Landcruiser 4.0L Diesel 2H 1980-1990 HJ60 HJ75 # 27020-68140

Dimension:280*240*195mm

Weight:7.65kg

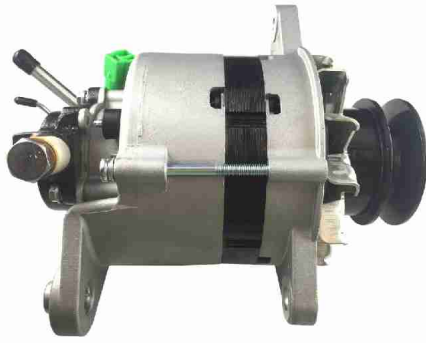

Price : (AUD)

ALTER-TA004 / Alternator Fit Toyota Landcruiser 4.0L Diesel 2H 1980-90 HJ60 HJ75 Internal Reg

Dimension:/
Weight: /



Price : (AUD)

ALTER-TA005 / Alternator TOYOTA HILUX 2.8L (3L) 2.4L (2L) DIESEL 1985-1993 High Output 80AMP

Dimension:280*240*195mm
Weight:7.25kg

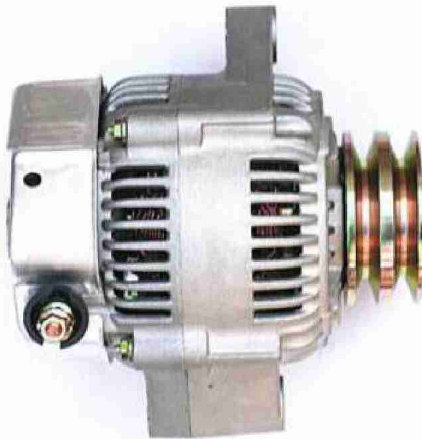

Price : (AUD)

ALTER-TA006 / Alternator fit Toyota Landcruiser FZJ80 engine 1FZ-FE 4.5L Petrol 92-05

Dimension:/
Weight: /



Price : (AUD)

ALTER-TA007 / Alternator Toyota 2AZ-FE RAV4 ACA33R ACA38R engine 2.4L Clutch Pulley 130A 06-14

Dimension:260*180*190mm
Weight:6.12kg



Price : (AUD)

**ALTER-TA008 / Alternator suit Toyota Hiace Hilux LN106
107 111 167 172 eng 3L 5L Diesel 91-05**

Dimension:260*180*190mm

Weight:6.58g

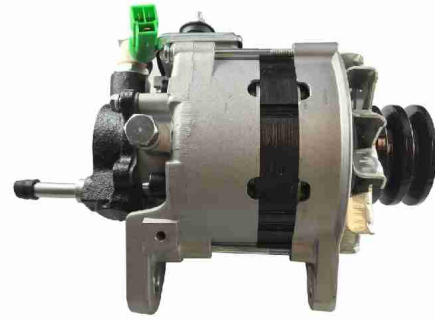

Price : (AUD)

**ALTER-TA009 / Alternator To Suit Toyota Hilux 2.4L (2L)
2.8 (3L) Diesel 85-93 (INTERNAL REG)**

Dimension:/

Weight:/



Price : (AUD)

**BJ-BA3263-A / AU BA BF Ford Upper Ball Joints Set
Front Falcon Fairlane BA3263-A 2pcs Express**

Dimension:120*90*60mm

Weight:0.8kg



Price : (AUD)

**BJ-BA3395-A / Front Lower Ball Joints Ford Falcon AU
BA BF Fairlane BA3395-A Sedan Wagon Ute**

Dimension:120*90*60mm

Weight:1kg



Price : (AUD)

BJ-FD425 / Falcon AU-1/2/3 BA BF Upper Front Ball Joints Ford Fairlane LTD BJ425 *Express*

Dimension:120*90*60mm

Weight:1kg



Price : (AUD)

BJ-FD426 / AU BA BF Ball Joints Ford Falcon Fairlane LTD Front Lower 2pcs BJ426 *Express*

Dimension:120*90*60mm

Weight:1kg



Price : (AUD)

BJ-FD317 / Ford Ball Joints Kit Fairlane NA-NL Falcon EA-EL LTD DA-DL1988-1998 BJ317 Upper

Dimension:120*90*60mm

Weight:1kg



Price : (AUD)

BJ-FD318 / Ford Ball Joints Kit Lower NA-NL Fairlane EA-EL Falcon DA-DL LTD 88-98 BJ318

Dimension:120*90*60mm

Weight:1kg

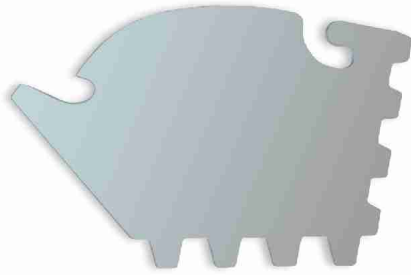

Price : (AUD)

**BBQT-001 / BBQ Tool Scraper Grill Cleaning 5 in 1 multi
Steam Cleaner bottle opener Steel**

Dimension: /

Weight: /



Price : (AUD)

**WH-FD001 / RONT WHEEL BEARING HUB SUIT FORD
FALCON XR6 XR8 AU BA BF INC FPV**

Dimension: 175*140*130mm

Weight: 3kg



Price : (AUD)

**WHLN-FD001 / Ford Falcon Nuts & ILJIN Front Wheel
Bearing Hubs AU/BA/BF SEDAN WAGON UTE**

Dimension: /

Weight: 0.05kg



Price : (AUD)

WH-HLN001L / V6 VU VZ Commodore Left Front Wheel Bearing Hub Holden VT 2 VY VX V8 ABS 3.8L

Dimension:110*110*70mm

Weight:4kg



Price : (AUD)

WH-HLN001R / Front Wheel Bearing Hub Holden Commodore Calais VT Series 2 VX VY VZ V6 ABS RH

Dimension:110*110*70mm

Weight:4kg



Price : (AUD)

WH-HLN002 / FW Hubs Isuzu DMax D-Max Holden Rodeo Jackaroo Colorado RG Frontera 4WD Trooper

Dimension:/

Weight:/



Price : (AUD)

WH-HLN003 / Holden Astra Rear Wheel Bearing Hub L&R Petrol Diesel 04-10 ABS AH 5 Stud 1.8L

Dimension:110*110*70mm

Weight:3.7kg



Price : (AUD)

**WH-JP001 / FRONT HUB WHEEL BEARING SUIT JEEP
CHEROKEE XJ 4.0L PETROL 1984 - 2001 4WD WAGON**

Dimension:180*160*145mm

Weight:5kg



Price : (AUD)

**WH-NS004KIT / Free Wheeling Hub Reinforcing Rings
For Nissan Patrol GQ GU**

Dimension:/

Weight:/

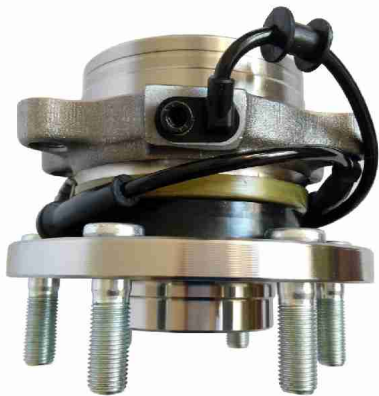

Price : (AUD)

**WH-NS006 / 1 FRONT WHEEL BEARING HUB NISSAN
NAVARA 4WD D22 D40 YD25/VQ40 ABS SPANISH 05-12**

Dimension:160*150*145mm

Weight:4.95kg



Price : (AUD)

**WH-MB002 / 2pcs Free Manual Wheeling Hub Lock
Mitsubishi Triton Pajero 28 Splines 88mm PCD**

Dimension:/

Weight:/



Price : (AUD)

WH-MB003 / Front Wheel Bearing Hub Suit For Mitsubishi Pajero NM, NP, NS, NT 05/2000-2009

Dimension:180*160*145mm

Weight:6.3kg



Price : (AUD)

WH-NS007 / FRONT WHEEL HUB KIT ELGRAND E51 02-10 INFINITI FX45/35 (S50) 02-08 43210-WL000

Dimension:125*65*125mm

Weight:1.6kg



Price : (AUD)

WH-NS008 / Front Wheel Bearing Hub Nissan Navara D40 D22 2.5TDI 4.0 YD25 Thailand Build ABS

Dimension:/

Weight:1kg



Price : (AUD)

WH-SU001 / SUZUKI VITARA PAIR OF FREE WHEEL BEARING HUBS (2 OF) 1988 ONWARDS BRAND NEW

Dimension:165*155*120mm

Weight:2kg



Price : (AUD)

**WH-SR001 / 1 x FRONT WHEEL HUB FOR LEGACY
OUTBACK B12 1997-2003 28362-AE000**

Dimension:165*155*120mm

Weight:1.6kg



Price : (AUD)

**WH-TA001 / FREE WHEELING HUBS TOYOTA
LANDCRUISER 105 79 SERIES FZJ105 HDJ105 HZJ105
HZJ79**

Dimension:165*155*120mm

Weight:1.18kg



Price : (AUD)

**WH-TA003 / 2pcs Free Wheeling Wheel Hub Lock
Manual Lock 26 spline Toyota Hilux 4WD 79-85**

Dimension:165*155*120mm

Weight:6kg

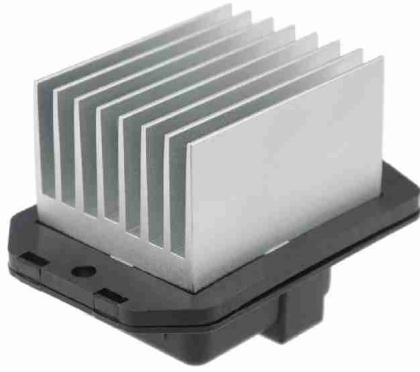

Price : (AUD)

HFR-HD001 / 8 Fins Honda CRV Blower Motor Heater Fan Resistor 2001-2006 077800-0710

Dimension:85*85*80mm

Weight:0.15kg



Price : (AUD)

HFR-HLN001 / Holden Colorado Isuzu D-Max Nissan Maxima RC Blower Motor Heater Fan Resistor

Dimension:102*62*62mm

Weight:0.05kg



Price : (AUD)

HFR-NS001 / Navara D40 Blower Motor Heater Fan Resistor Pathfinder R51 Manual 2005-2013

Dimension:/

Weight:0.05kg



Price : (AUD)

HFR-NS002 / Nissan Pulsar N15 Navara D22 Blower Motor Heater Fan Resistor Manual Climate

Dimension:/

Weight:0.05kg



Price : (AUD)

HFR-NS003 / Blower Motor Heater Fan Resistor for
Pathfinder R50 95-04 Patrol GU 97-13

Dimension:103*63*103mm

Weight:0.05kg



Price : (AUD)

HFR-NS004 / Nissan Blower Motor Heater Fan Resistor
X-Trail T30 Maxima A33 27761-9W100 NEW

Dimension:130*93*55mm

Weight:0.15kg



Price : (AUD)

HFR-NS005 / Blower Motor Heater Fan Resistor for
Nissan X-Trail T30 27150-8H300 2001-ON

Dimension:78*48*85mm

Weight:0.05kg



Price : (AUD)

ABS-HLN001 / Holden Commodore VE Rear Wheel Speed ABS Sensor and Statesman WM 92211237 New

Dimension:/
Weight: /



Price : (AUD)

BS-BZ001 / Gas Bonnet Struts for Mercedes Benz W163 Series ML55 ML270 ML350 ML430 Set of 2

Dimension:85*50*285mm
Weight:0.45kg



Price : (AUD)

BS-FD001 / Ford Falcon ED EF EL EA EB Gas Bonnet Struts Fairmont 88-98 Lift Support New Set

Dimension:570*180*35mm
Weight:0.65kg



Price : (AUD)

BS-FD002 / 2x Tailgate Struts Gas Springs Boot Set for Ford Focus Hatchback MK2 2005-2010

Dimension:590*80*30mm
Weight:0.65kg



Price : (AUD)

**BS-FD003 / Pair Bonnet Gas Struts Ford BA BF Falcon
FPV XR6 XR8 GT GTP Fairlane 2002-2008**

**Dimension: /
Weight: /**



Price : (AUD)

**BS-HLN001 / HOLDEN COMMODORE STATESMAN GAS
BONNET STRUTS SUIT SS VT VX VU VY VZ WH WK WL**

**Dimension: 570*180*35mm
Weight: 0.65kg**



Price : (AUD)

**BS-HLN002 / Holden Commodore VT VX VU VY VZ
Wagon Tailgate Gas Struts Rear Left & Right**

**Dimension: 590*80*30mm
Weight: /**



Price : (AUD)

**BS-JP001 / Jeep Grand Cherokee Gas Tailgate Struts
Pair WJ WG 99-2004 Laredo Sport Limited**

**Dimension: 590*80*30mm
Weight: /**



Price : (AUD)

BS-NS001 / Nissan GU Patrol 1997+ Heavy Duty Bonnet Gas Struts - Brand New Pair

Dimension:570*80*35mm

Weight:0.6kg



Price : (AUD)

BS-NS002 / Bonnet Gas Strut fit Toyota Hilux Vigo SR5 Hood Damper Lift Kit 2005-2012

Dimension:/

Weight:/



Price : (AUD)

BS-TA001 / 1 Pair Front Bonnet Gas Struts Toyota Landcruiser 80 Series 90-97 Lift Support

Dimension:570*80*35mm

Weight:0.85kg



Price : (AUD)

BS-TA002 / Toyota Landcruiser Gas Bonnet Struts 100 Series FZJ HDJ HZJ 6/98-2007 New Pair

Dimension:570*80*35mm

Weight:0.8kg



Price : (AUD)

BS-TA003 / Toyota Landcruiser 80 Series Tailgate Gas Struts 90-97 / Springs Rear Left Right

Dimension:570*180*35mm

Weight:0.75kg



Price : (AUD)

BS-TA004 / Pair Front Bonnet Gas Struts Toyota Landcruiser Prado 120 Series 2002-2009

Dimension:590*80*30mm

Weight:0.65kg



Price : (AUD)

BS-TA005 / Gas Bonnet Strut Toyota Camry ACV40 AHV40 Aurion Sedan 06-11 Lift Support Kit

Dimension:740*50*40mm

Weight:/



Price : (AUD)

BS-TA006 / Nissan Navara D40 05-13 Bonnet Gas Struts Damper Kit Pair- Thai or Spain Build

Dimension:590*80*30mm

Weight:/



Price : (AUD)

**BS-TA007 / TAILGATE GAS STRUTS 100 SERIES
TOYOTA LANDCRUISER REAR 98-07 Rear Left and Right**

**Dimension:570*180*35mm
Weight:0.75kg**



Price : (AUD)

**BS-TA008 / Set of 2 Bonnet Gas Struts for Toyota Camry
MCV20 SXV20 Sedan Wagon 1997-2001**

**Dimension:80*35*480mm
Weight:0.6kg**



Price : (AUD)

**BH-NS001 / Extended Brake Lines Hose Kit fits 2"-5"
spring lift Nissan Patrol GQ Y60 GU Y61**

**Dimension:/
Weight:0.5kg**



Price : (AUD)

**BH-NS003004 / Extended Brake Hose/Line kit - for
Nissan Patrol GQ (Y60) GU (Y61) Maverick**

**Dimension:/
Weight:0.35kg**

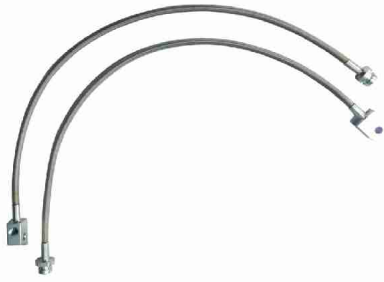

Price : (AUD)

**BH-NS005006 / Extended Stainless Braided Brake Lines
Nissan Patrol GQ Y60 GU Y61 2-8" Lift Kit**

Dimension:/
Weight:0.3kg



Price : (AUD)

**BH-NS007 / Braided' Extended Brake Hose/Line kit - for
Nissan Patrol GQ (Y60) GU (Y61)**

Dimension:/
Weight:0.4kg



Price : (AUD)

**BH-NS008 / Brake Caliper Hose SET (Front & Rear) - for
Nissan Patrol GQ Maverick (88-97)**

Dimension:/
Weight:0.5kg



Price : (AUD)

**BH-NS009 / Brake Caliper Hose SET (Front & Rear) - for
Nissan Patrol GQ Maverick (88-97)**

Dimension:/
Weight:0.5kg



Price : (AUD)

BH-TA001 / Pair Front Brake Hoses Lines Toyota Landcruiser 60 70 75 Series HZJ75 FJ75 HJ60

**Dimension:/
Weight: /**



Price : (AUD)

BH-TA002 / Toyota Rear Extended Brake Line Hose Hilux RN46 YN65 YN67 RN105 LN106 4Runner

**Dimension: /
Weight: /**

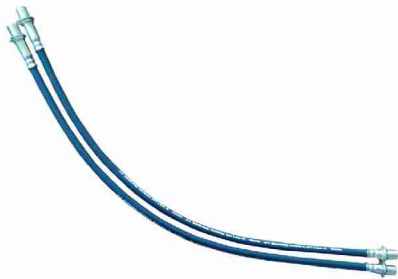

Price : (AUD)

BH-TA003 / Set 2 Front Extended Brake Hose Line Hilux 4x4 LN106 RN105 LN65 YN65 YN67 88-97

**Dimension: /
Weight: /**



Price : (AUD)

CMC-NS005 / Clutch Master Cylinder fit Nissan GQ Y60
Patrol Ford Maverick DA w/Booster 4x4

Dimension:270*130*70mm

Weight:2kg



Price : (AUD)

CMC-TA001 / Clutch Master Cylinder BJ70 BJ73 FJ70
FJ73 HJ75 Toyota Landcruiser 70 Series

Dimension:270*130*70mm

Weight:1kg



Price : (AUD)

CMC-TA003 / New Toyota Clutch Master Cylinder
Landcruiser BJ42 FJ40 FJ45 FJ60 31410-60050

Dimension:270*130*70mm

Weight:2kg



Price : (AUD)

CMC-TA004 / LN106 LN107 LN111 Clutch Master
Cylinder Toyota Hilux Diesel 88-97 31410-35250

Dimension:270*130*70mm

Weight:1kg



Price : (AUD)

CSC-NS001 / Nissan & Ford Clutch Slave Cylinder Patrol GQ Maverick DA Y60 4.2L 30620-01J01

Dimension:70*60*110mm

Weight:0.5kg



Price : (AUD)

CSC-TA002 / Clutch Slave Cylinder TOYOTA CROWN YS GS LS JZS13 LEXUS IS I 31470-30270

Dimension:145*95*65mm

Weight:0.45kg



Price : (AUD)

BUSH-BMW001 / Control Arm Wishbone Front Lower Bush Kit BMW E46 316 318 320 323 325 330 96-06

Dimension:190*140*80mm

Weight:1.6kg



Price : (AUD)

BUSH-NS001-NS002 / Panhard Rod Rubber Bush Kit Fit Nissan Patrol GQ Y60 GU Y61 Front & Rear Ute 4x4

Dimension:120*90*60mm

Weight:0.4KG



Price : (AUD)

BUSH-NS003 / Rear Upper Lower Control Trailing Arm Bush Kit for Nissan Patrol GQ Y60 GU Y61

Dimension:190*140*75mm

Weight:1.05KG



Price : (AUD)

BUSH-NS004 / Nissan & Ford Radius Arm Rear Rubber Bush Kit Patrol GQ GU Y60 Y61 Maverick DA

Dimension:190*140*75mm

Weight:0.4kg



Price : (AUD)

BUSH-NS005 / Patrol GQ GU Radius Arm Bush Kit Front fit Nissan & Ford Y60 Y61 DA 48705-60050

Dimension:190*140*75mm

Weight:1.25kg



Price : (AUD)
CARB-GY6001 / GY6 PD24mm Carburetor Carb ATV Buggy Quad Scooter Go Kart 110cc 125cc Buggy

Dimension:120*140*140mm
Weight:0.7kg

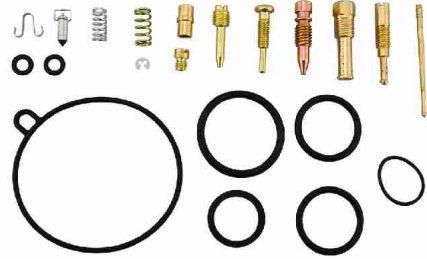

Price : (AUD)
CARB-KIT001 / Carburetor Carby Rebuild Kit Honda CT110 Postie Posty Bike All Models

Dimension:55*35*75mm
Weight:0.022kg



Price : (AUD)
CARB-PZ019 / PZ19mm Lever Choke Carburetor Carb Carby 90cc 110cc 125cc ATV Bike Dirt Pit Quad

Dimension:145*90*80mm
Weight:0.45kg



Price : (AUD)
CARB-PZ022 / PZ22 22mm Carby Lever Choke Carburetor 110cc 125cc PIT Quad Dirt Bike ATV Buggy

Dimension:145*90*80mm
Weight:0.45kg



Price : (AUD)

CARB-PZ026 / PZ 26mm Lever Choke Carburetor
125 140 150cc PIT PRO Trail Dirt Quad Bike

Dimension:140*110*90mm

Weight:0.5kg



Price : (AUD)

CARB-PZ030 / PZ30 30mm Lever Choke Carburetor Carb
Carby 150cc 200cc 250cc ATV Bike Dirt Pit

Dimension:142*115*83mm

Weight:0.55kg



Price : (AUD)

CYL-PW050 / Yamaha Engine Rebuild Kit Head Bore
Cylinder Barrel Piston Ring PW50 PY50 PW60

Dimension:240*160*150mm

Weight:2kg



Price : (AUD)

CYLKIT-PW050A / Engine Head Bore Barrel Cylinder
Piston Rings YAMAHA PW50 PY50 PEEWEE Bike 40mm

Dimension:240*160*150mm

Weight:2.2kg



Price : (AUD)

CB-HLN001 / 1 x Holden Commodore Tailshaft Centre Bearing VX VY VZ V8 Sedan

Dimension:180*158*60mm

Weight:0.65kg



Price : (AUD)

CB-MB001 / Mitsubishi Centre Bearing Mount Support Triton ME MF MG MH MJ MK L200 Ute 4x4

Dimension:185*125*60mm

Weight:1.05kg



Price : (AUD)

CB-NS001 / Centre Bearing Support Nissan Navara D21 D22 Driveshaft Frontie Pathfinder Ute

Dimension:303*170*88mm

Weight:0.5kg



Price : (AUD)

CB-TA001 / Toyota Hilux Centre Bearing RN60 RN63 RN65 RN105 4x4 Petrol Carrier Assembly

Dimension:303*170*88mm

Weight:2.8kg



Price : (AUD)

CB-TA002 / Toyota Hilux Tailshaft Centre Bearing Ute RWD 1983-97 LN RN YN Series Pickup

Dimension:303*170*88mm
Weight:2kg



Price : (AUD)

CB-TA003 / Toyota Driveshaft Centre Cushion Bearing Assembly Crown MS122 MS123 MS125 83-88

Dimension:303*170*88mm
Weight:2kg



Price : (AUD)

CB-TA004 / Driveshaft Centre Bearing Toyota Hilux 4x4 KZN165 RZN169 RZN174 VZN167 VZN172

Dimension:125*125*-60mm
Weight:0.7kg



Price : (AUD)

CLIP-001 / Car Door Trim Panel Rivet Fasteners Fender Clips 10mm Hole 100 Pcs for Toyota

Dimension:/
Weight: /



Price : (AUD)

CLIP-002 / 40 Black Plastic Rivet Interior Trim Panel Car Door Retainer Clips Push 8mm Hole

Dimension: /
Weight: /



Price : (AUD)

CLIP-003 / 100 Bumper Bar Inner Guard Radiator Cowl Air Box Scrivet Clip Holden 92138218

Dimension: /
Weight: /



Price : (AUD)

CLIP-FD001 / 10PCS Plastic Mud Flap Retainer Clip Ford Falcon AU BA BF FG XR6 XR8 G6E Turbo

Dimension: /
Weight: /



Price : (AUD)

CLIP-FD002 / 50 x Plastic Clip Retainers For Ford EL EF AU BA BF FG XR6 XR8 G6E Turbo Falcon

Dimension:/
Weight: /



Price : (AUD)

CLIP-FD003 / FORD FALCON + TERRITORY 100 SET SCRIVETS CLIP PLASTIC PINS AU BA BF FG SX SY SZ

Dimension: /
Weight: /



Price : (AUD)

CLIP-HLN001 / 10 Push Retainer Clips Holden Commodore VE SS SV6 OMEGA HSV Bulk Lots VE Front

Dimension: /
Weight: /



Price : (AUD)

CLIP-HLN002 / 100 X FASTENER CLIPS SUIT HOLDEN COMMODORE VY VE BUMPER RADIATOR COWL TRIM CLIP

Dimension: /
Weight: /



Price : (AUD)

**CLIP-MA001 / Set of 10 Door Trim Panel Retainer Plastic
White Clips Mazda 323 626 CX7 Premacy**

**Dimension:/
Weight: /**



Price : (AUD)

**CLIP-TA001 / Panel Flare Clips For Toyota Land Cruiser
Prado 120 Front Body Trim Mould Repair**

**Dimension: /
Weight: /**



Price : (AUD)

**CLIP-SR001 / 5 x Subaru 10mm Hole Bumper Fastener
Clip Door Boot Trim Panel Plastic Rivet**

**Dimension: /
Weight: /**



Price : (AUD)

CS-NS001(2PCS) / Nissan PATROL GQ GU Y60 Y61
30mm FRONT Coil Spring Spacers Lift Kit 4x4 Maverick

Dimension:980*230*17mm

Weight:2kg



Price : (AUD)

CS-NS001(2PCS)/CS-NS002(2PCS) / Coil Spring Spacer
30mm Lift Kit Nissan Patrol GQ GR GU Y60 Y61 Ford
Maverick

Dimension:980*230*17mm

Weight:3kg



Price : (AUD)

CS-NS002(2PCS) / 30mm Rear Coil Spring Spacer
Nissan Patrol GQ GR GU Y60 Y61 Poly Safari Maverick

Dimension:980*230*17mm

Weight:2kg



Price : (AUD)

CS-NS003(2PCS) / 2 POLY REAR 50mm Coil Spring
Spacer Nissan Patrol GQ GU Y60 Y61 Safari Maverick

Dimension:980*230*17mm

Weight:2kg



Price : (AUD)

CS-NS003(2PCS)/CS-NS004(2PCS) / Pair FRONT & REAR
50mm Lift Coil Spacers Kit Nissan GQ GU Y60 Y61
PATROL 4x4

Dimension:980*230*17mm

Weight:2.2kg



Price : (AUD)

CS-NS004(2PCS) / 50mm Coil Spring Spacer Nissan
Patrol GQ GU Y60 Y61 Maverick Poly Safari Rear

Dimension:980*230*17mm

Weight:2kg



Price : (AUD)

CAKIT-AU003 / FOR AUDI A4 A6 VW PASSAT
COMPLETE SET FRONT SUSPENSION CONTROL ARMS
KIT

Dimension:450*380*150mm

Weight:12kg



Price : (AUD)

CAKIT-BMW001 / BMW E46 316 318 Front Lower Control
Arm Bushing Kit 320 325 328 330 Z4 99-05

Dimension:570*370*330mm

Weight:8.5kg



Price : (AUD)

CAKIT-BMW002 / BMW Front Lower Suspension Control Arm Bushing Kits Set Tie Rod E46 2WD 323Ci

Dimension:/
Weight: /



Price : (AUD)

CAS-HLN001 / Crank Angle Sensor Holden Commodore V6 VN VP VR VS VT VNII 3.8L10456161 88-04

Dimension:130*90*48mm
Weight:0.15kg



Price : (AUD)

CAS-HLN002 / Cam Angle Sensor fits Holden Astra TS AH 1.8L X18ZE Z18XE 4Cyl CAM003 Camshaft

Dimension: /
Weight: /



Price : (AUD)

CAS-NS001 / Crank Angle Sensor fits NISSAN X-TRAIL
T30 QR25DE 2.5L XTRAIL Crankshaft CAS

Dimension:/
Weight: /



Price : (AUD)

CPS-BMW001 / Cam Angel Sensor / Camshaft Position
Sensors Fit For BMW E46 E39 E53 E60 E85 E90

Dimension: /
Weight: /



Price : (AUD)

SMS-TA001 / OEM Speedo Speedometer Sensor Toyota
Landcruiser Land Cruiser 78 79 80 Series

Dimension: /
Weight: /



Price : (AUD)

CVS-TA001 / CV Shaft Toyota Hilux IFS 4x4 1988-2005
Boot Axle Joint LN107 LN111 RN110 KZN165

Dimension:1320*245*145mm

Weight:10kg



Price : (AUD)

CVS-TA002 / Toyota Hilux 150 Series KUN26R GGN25R
CV Joint Drive Shaft 05-09 Left + Right
ball cage assembly(Normal)

Dimension: /

Weight: /



Price : (AUD)

DL-GEAR / 1pc Ford Door Actuator Cog Falcon AU 3 BF
BA Territory Lock Actuator Gear 5.7mm

Dimension: /

Weight: /



Price : (AUD)

DLKIT-FD / Door Lock Actuator Repair Kit FORD Falcon
Series 1 2 3 AU BA BF Territory Laser

Dimension: /

Weight: /

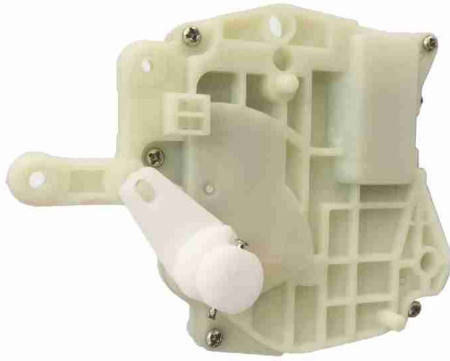

Price : (AUD)

DL-HD001 / Power Door Lock Actuator Honda Left Front Side Civic Accord Odyssey Acura MDX

Dimension:/
Weight: /

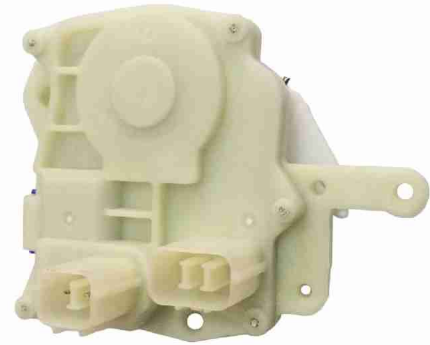

Price : (AUD)

DL-HD002 / Honda Power Door Lock Actuator Front Right Civic Accord Odyssey CRV Acura MDX TL

Dimension: /
Weight: /



Price : (AUD)

DL-HD003 / Honda Accord Door Lock Actuator Rear Left Front Left TL LX TSX DX EX 72155SDAA01

Dimension:140*95*35mm
Weight:0.15kg

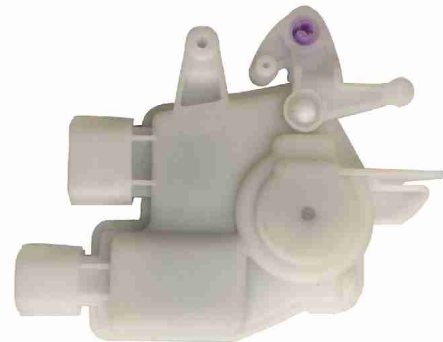

Price : (AUD)

DL-HD004 / Door Lock Actuator Honda Accord Front Right/ Rear Right TL TSX DX EX 72115SDAA01

Dimension: /
Weight: /



Price : (AUD)

**DL-HD005 / DOOR LOCK ACTUATOR HONDA CRV
ACCORD INTEGRA ODYSSEY CIVIC PILOT ACURA LEFT**

**Dimension:/
Weight: /**



Price : (AUD)

**DL-HD006 / HONDA CRV ACCORD ODYSSEY CIVIC
DOOR LOCK ACTUATOR FRONT RIGHT SIDE**

**Dimension: /
Weight: /**



Price : (AUD)

**DL-TA001 / Door Lock Actuator fits Toyota Echo Scion
xB Front Left Side 00-05 69120-52030**

**Dimension:130*95*140mm
Weight:0.15kg**



Price : (AUD)

**DL-TA002 / Door Lock Actuator fits Toyota Echo Scion
xB Front Right Side 00-05 Brand New**

**Dimension:130*95*140mm
Weight:0.15kg**



Price : (AUD)

DSC-BOLT001 / SET OF 3 Tailshaft Coupling Bolts Nut
Holden Commodore VT VX VU VY VZ WH WK WL

Dimension:/
Weight: /



Price : (AUD)

DSC-HLN001 / Holden Rear Tail Shaft Rubber Coupling
Disc for Commodore VT VU VX VY V6 3.8 AT

Dimension:138*135*40mm
Weight:0.55kg

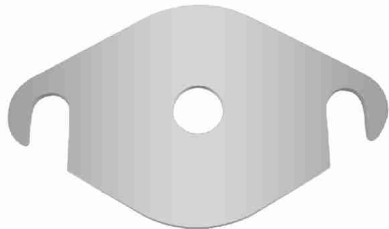

Price : (AUD)

BP-FD001 / EGR Blanking Plate Ford Ranger PX
ZSD-422 2.2L PUMA P5AT 3.2L / Mazda BT50 B22

Dimension: /
Weight:0.05kg

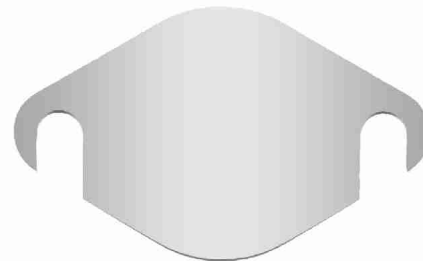

Price : (AUD)

BP-FD002 / EGR Blanking Plate TO Ford Ranger PX
PUMA P5AT 3.2L turbo diesel 2010-ON NO Hole

Dimension: /
Weight:0.05kg

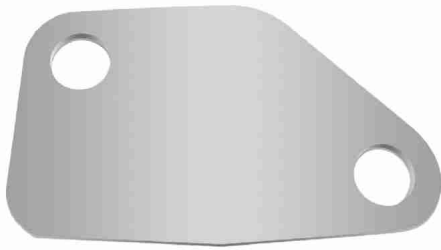

Price : (AUD)
BP-FD003 / EGR Blanking Block Off Plate Pajero L2/3/400 VM 2.5/2.8/3.2 Ford Fiat Jeep Alfa

Dimension:/
 Weight:0.05kg

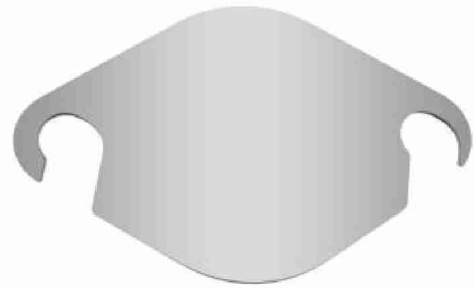

Price : (AUD)
BP-FD004 / EGR Blanking Plate Block off Plate - Ford Ranger 3.2 Manual / BT-50 (2011-2014)

Dimension:/
 Weight:0.05kg

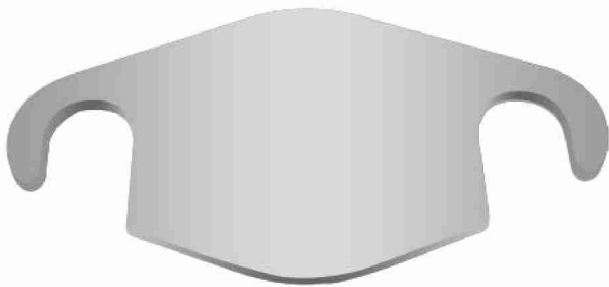

Price : (AUD)
BP-FD005 / EGR Blanking Plate Plate Ford Ranger PJ PK Auto or Manual 2007-2011

Dimension:/
 Weight:0.05kg



Price : (AUD)
BP-FD006 / Mustang Ford EGR Block Off Delete Plate w/Gasket 1987 - 1993 5.0 5L

Dimension:/
 Weight:0.05kg

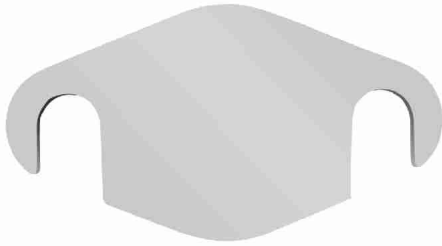

Price : (AUD)

BP-FD012 / EGR Blanking Plate Mazda BT-50 2.5L & 3.0L Duratorq TDCi motor Stainless Steel

Dimension:/
Weight:0.05kg

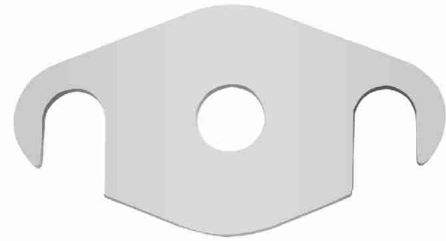

Price : (AUD)

BP-FD013 / Mazda Bt-50 BT50 2.5 & 3.0L Duratorq TDCi EGR Block Blanking Plate with hole

Dimension:/
Weight:0.05kg

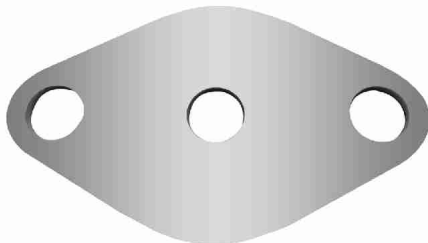

Price : (AUD)

BP-FT001 / EGR Valve Blanking Block Plate VAUXHALL 1.9 CDTi Saab 1.9 Tid 2mm 304 Steel

Dimension:/
Weight:0.05kg

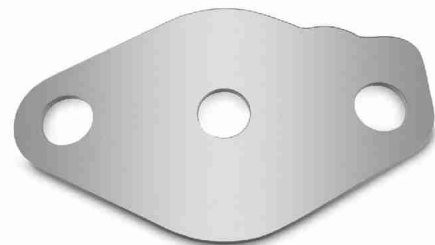

Price : (AUD)

BP-GW001 / EGR Blanking Plate Great Wall V200 & X200 2011-ON 2.0L 4cyl Diesel TD with Hole

Dimension:/
Weight:0.05kg

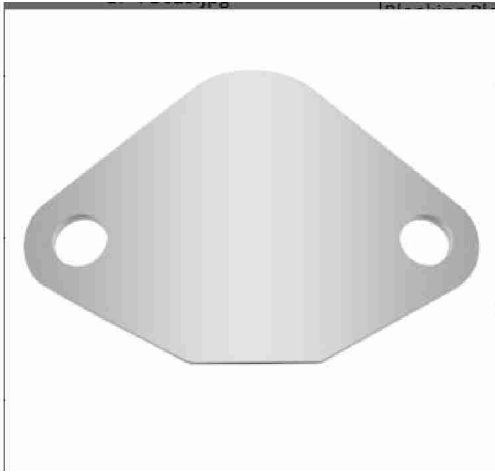

Price : (AUD)

BP-HD001 / EGR Blanking Block Plate Honda Accord Prelude Civic Jazz Shuttle Petrol Engine

Dimension:/
Weight:0.05kg

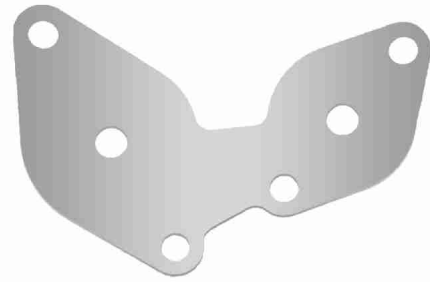

Price : (AUD)

BP-HLN001 / EGR Blanking Block Plate Holden Colorado RC Rodeo RA 4JJ1 3.0L TD Isuzu DMAX TF

Dimension:/
Weight:0.05kg



Price : (AUD)

BP-HLN002 / HOLDEN EGR BLANKING PLATE RC COLORADO / D-MAX / DMAX / RODEO RA BLOCK OFF Isuzu

Dimension:/
Weight:0.05kg

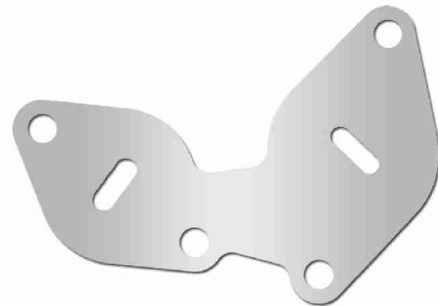

Price : (AUD)

BP-HLN003 / 4JJ1 EGR Blanking Plate Isuzu DMAX D-Max TF 3.0L turbo diesel Best Performance

Dimension:/
Weight:0.05kg

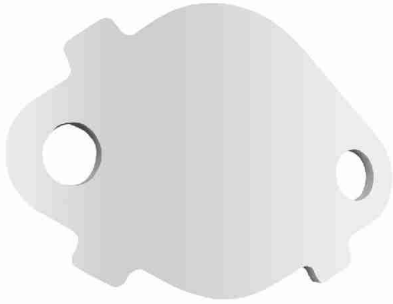

Price : (AUD)

BP-HLN004 / Holden 2.8L RG Colorado EGR Blanking Plate Late 2013-ON MY14 MY15 MY16

Dimension: /
Weight:0.05kg

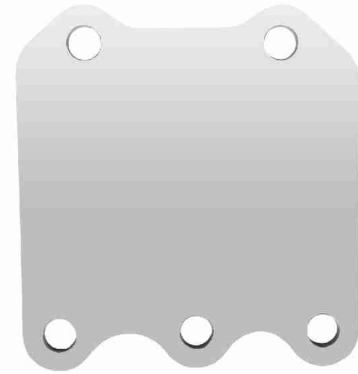

Price : (AUD)

BP-HLN005 / Holden EGR Cooler Blanking Plate RG Colorado 2.8L Turbo Diesel TD 2012-ON

Dimension: /
Weight:0.05kg

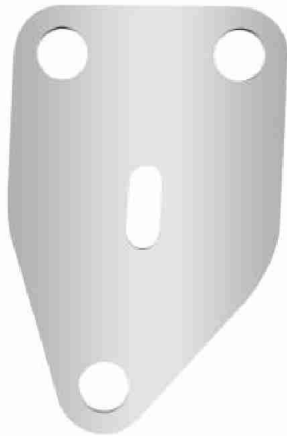

Price : (AUD)

BP-IS001 / Isuzu 3.0 Dmax EGR Blanking Plate 2012-2013-2014-2015 Easy Use Design

Dimension: /
Weight:0.05kg

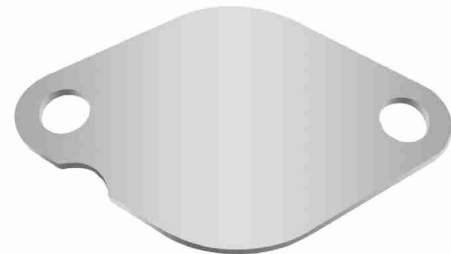

Price : (AUD)

BP-LR001 / EGR Blanking Plate Suit Land Rover Discovery TD5 Series 2 Turbo Diesel

Dimension: /
Weight:0.05kg

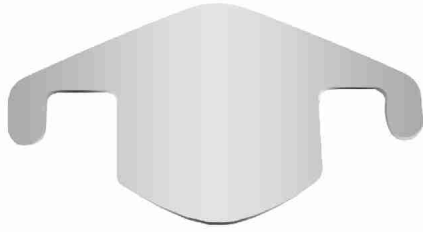

Price : (AUD)

BP-MB001 / EGR Blanking Plate - Mitsubishi Triton 3.2L & 2.5L engine

Dimension:/
Weight:0.05kg



Price : (AUD)

BP-MB002 / EGR Blanking Plate Mitsubishi Triton MN ML 3.2 2.5 TD Pajero Challenger w Hole

Dimension:/
Weight:0.05kg

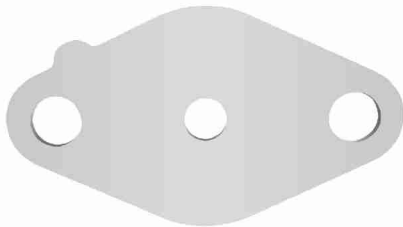

Price : (AUD)

BP-MB003 / EGR Blanking Plate Suit Mitsubishi MQ Triton & Pajero Sport 2.4L 4cyl

Dimension:/
Weight:0.05kg

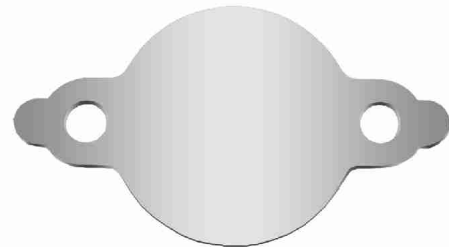

Price : (AUD)

BP-NS001 / EGR Blanking Plate Nissan Patrol GU Y61 ZD30 Turbo Diesel Common Rail No Hole

Dimension:/
Weight:0.05kg



Price : (AUD)

BP-NS002 / EGR Blanking Block Plate Nissan Patrol TD42 Ti 4.2L Turbo Diesel

Dimension: /
Weight: 0.05kg

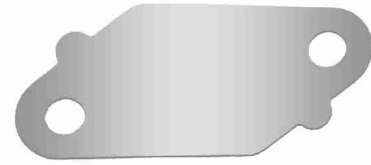

Price : (AUD)

BP-NS003 / Nissan Patrol GU Y61 ZD30 3.0L Turbo Diesel Direct Injection EGR Blanking plate

Dimension: /
Weight: 0.05kg

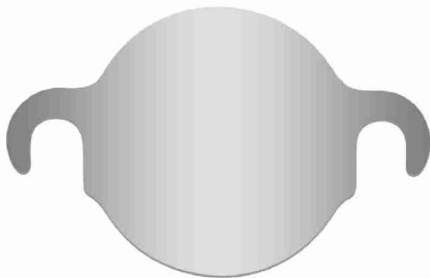

Price : (AUD)

BP-NS004 / Nissan ZD30 Patrol EGR Blanking Block off Plate 3.0L CRD / Navara 63mm Hole C/C

Dimension: /
Weight: 0.05kg

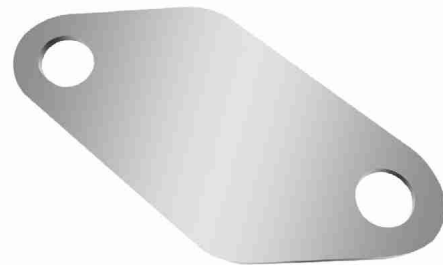

Price : (AUD)

BP-NS005 / EGR Blanking Plate fit Nissan Euro3 Navara Patrol Pathfinder X-trial YD25 YD22

Dimension: /
Weight: 0.05kg

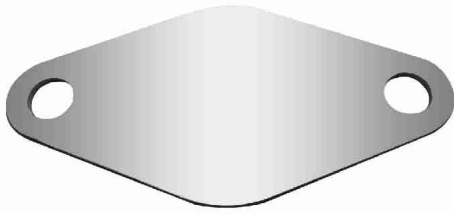

Price : (AUD)

BP-NS006 / Nissan EGR Blanking Plate Patrol Navara D22 Direct Injection ZD30 3.0L DI engine

Dimension:/
Weight:0.05kg

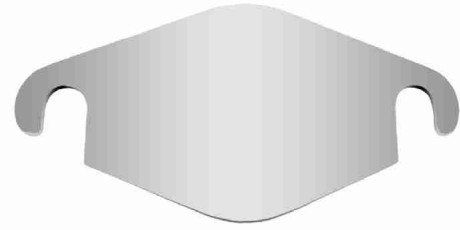

Price : (AUD)

BP-NS007 / EGR Blanking Plate Nissan ZD30 Direct Injection DI Patrol GU Navara D22 70mm C/C

Dimension:/
Weight:0.05kg



Price : (AUD)

BP-NS008 / EGR Blanking Plate Fits Nissan Navara D22 D40 YD25 Diesel Common Rail with hole

Dimension:/
Weight:0.05kg

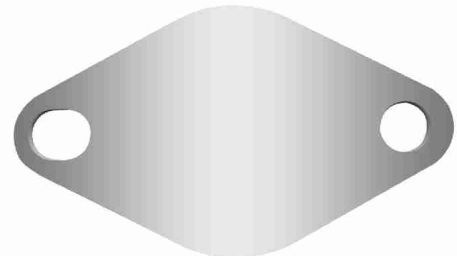

Price : (AUD)

BP-NS009 / Nissan Navara D40 2.5L TD Euro 5 Spec EGR Blanking Plate Stainless Steel

Dimension:/
Weight:0.05kg

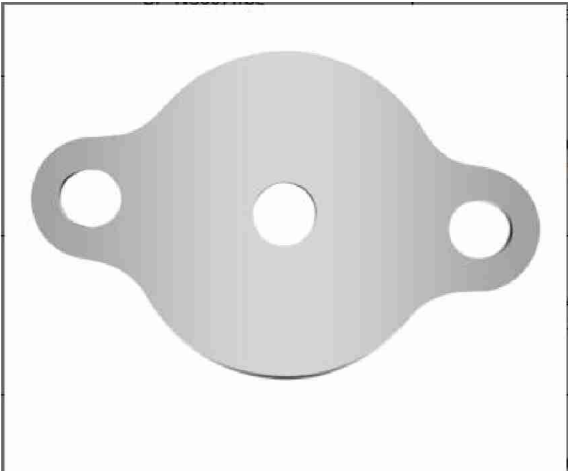

Price : (AUD)

BP-NS010 / EGR Blanking plate Nissan Patrol Navara 3.0ltr CRD Common Rail Diesel with Hole

Dimension:/
Weight:0.05kg

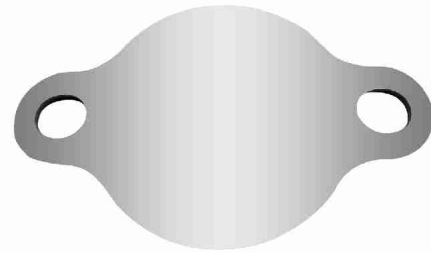

Price : (AUD)

BP-NS011 / EGR Blanking plate Nissan Patrol Navara 3.0ltr CRD Common Rail Diesel NO Hole

Dimension:/
Weight:0.05kg

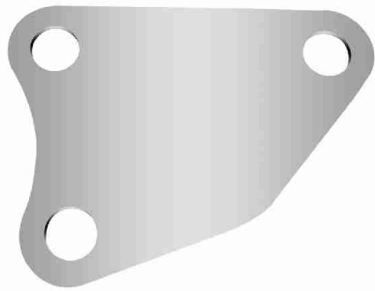

Price : (AUD)

BP-NS012 / Nissan Patrol GU ZD30 Common Rail Diesel CRD EGR Blanking Plate

Dimension:/
Weight:0.05kg

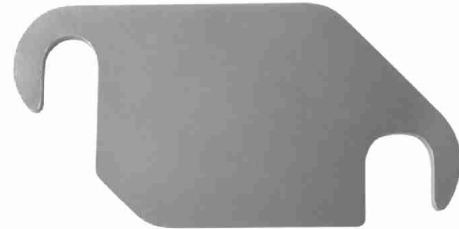

Price : (AUD)

BP-NS013 / EGR BLANKING PLATE NISSAN YD25 EURO 3 SPEC ENGINE 2006 NAVARA D22 NAVARA D40

Dimension:/
Weight:0.05kg



Price : (AUD)

**BP-NS014 / Nissan ZD30 Direct Injection Navara YD25
2.5L Euro 3 till 06 EGR Blanking plate**

Dimension:/
Weight:0.05kg

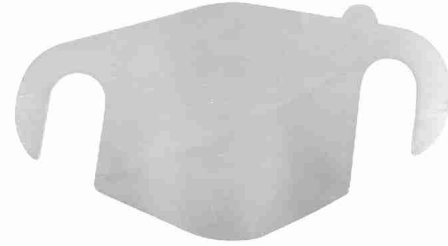

Price : (AUD)

**BP-NS015 / EGR Blanking Plate to suit Nissan NP300
Navara D23 2.3L Models**

Dimension:/
Weight:0.05kg

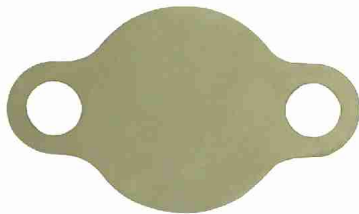

Price : (AUD)

**BP-TA001 / Toyota D4D EGR Blanking Plate 1KD-FTV
3.0L TD Hilux Prado KUN16 26 KDJ 120 150**

Dimension:/
Weight:0.05kg



Price : (AUD)

**BP-TA002 / EGR Blanking Plate for Toyota Landcruiser
100 78 79 105 1HZ Turbo Diesel**

Dimension:/
Weight:0.05kg

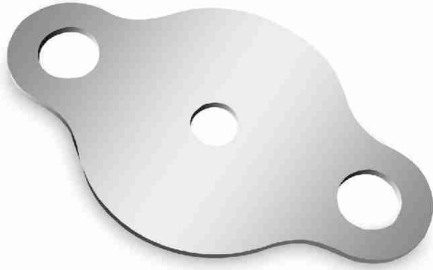

Price : (AUD)

BP-TA003 / EGR Blanking Plate for Toyota D4D 1KD-FTV 3.0 TD Hilux Prado with 7mm Hole

Dimension:/
Weight:0.05kg



Price : (AUD)

BP-TA004 / 6mm Hole EGR Blanking Plate Toyota D4D 1KD-FTV 3.0 Turbo Diesel Hilux Prado

Dimension:/
Weight:0.05kg

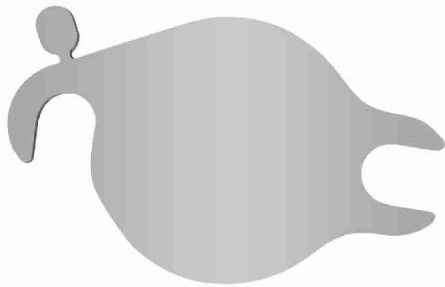

Price : (AUD)

BP-TA005 / EGR Blanking Plate Toyota Hilux Prado D4D 1KD-FTV 3.0 Turbo Diesel TD Stainless

Dimension:/
Weight:0.05kg

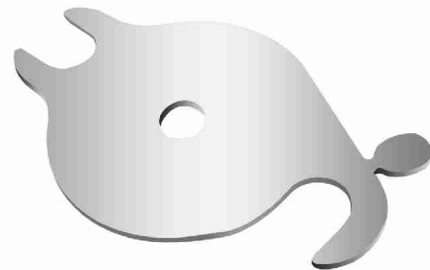

Price : (AUD)

BP-TA006 / EGR Blanking Plate fit Toyota D4D 1KD-FTV 3.0 TD Hilux Prado 7mm Hole New Design

Dimension:/
Weight:0.05kg

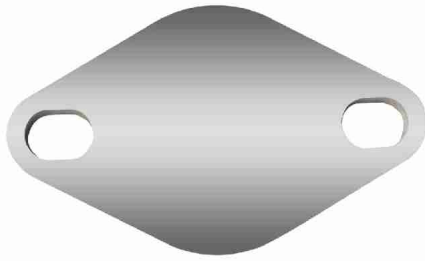

Price : (AUD)
BP-VW004 / 1 x EGR Valve Blanking Plate VW TDi Seat TDi Skoda TDi Audi TDi T5 T25 Stainless

Dimension:/
 Weight:0.05kg

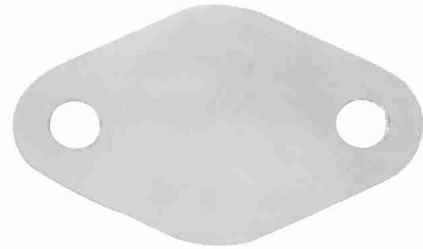

Price : (AUD)
BP-VW005 / EGR Blanking Plate Fits VW Amarok 2.0 BiTDi Manual Auto MY11 MY12 MY13 MY14

Dimension:/
 Weight:0.05kg



Price : (AUD)
BP-YMH001&CHIP-001 / Yamaha Catalytic D Plate & Cat Removal Chip 800 1200 1300 XLT GPR Waverunner R

Dimension:/
 Weight: /

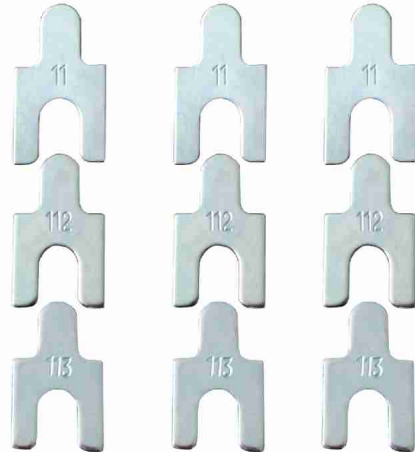

Price : (AUD)
CS-HLN001 / Set of 9 Holden Camber Shims Front End Wheel Alignment HQ HJ HX HZ WB LH LX UC

Dimension:/
 Weight:0.05kg

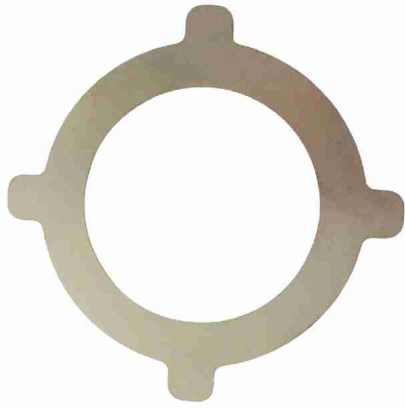

Price : (AUD)

**SHIM-NS001 / Limited Slip diff Shim Nissan Patrol GQ
Y60 GU Y61 Rear diff lock LSD 0.7mm**

**Dimension:/
Weight:0.05kg**



Price : (AUD)

**EGRV-HLN001 / Holden EGR Valve RA Rodeo 3.5L
(6VE1) Jackaroo 3.5L Frontera UT 3.2L (6VD1) 6Cyl**

**Dimension:110*95*135mm
Weight:1kg**



Price : (AUD)

EM-FD001 / 2 Front Heavy Duty Engine Mounts Ford Falcon Fairlane BA BF 2002-2008 4.0L 6cyl

Dimension:305*140*120mm

Weight:2.2kg

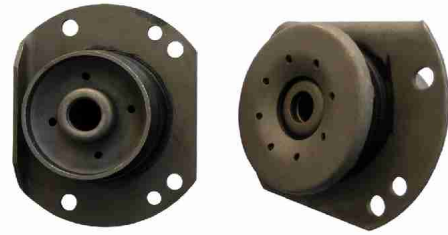

Price : (AUD)

EM-HLN001 / 2 x Front Rubber Castor Rod Bush Kit Commodore VT VX VY VZ V6 V8 Caster 97-06

Dimension:305*140*125mm

Weight:0.5kg



Price : (AUD)

EM-HLN002 / 2 Holden V6 Engine Mount Commodore VG VP VR VS VT VU VY Ute 3.8L Front Pair

Dimension:305*140*125mm

Weight:3.2kg



Price : (AUD)

EM-HLN003 / OEM Quality Front Engine Mount to suit Holden Astra TS AH 98-10 1.8L Automatic

Dimension:160*115*115mm

Weight:0.9kg



Price : (AUD)

EM-HLN005 / Holden Commodore VT VU VX VY VZ V8
GEN3 5.7L 6.0L Hydraulic Engine Mount x 2

Dimension:305*140*125mm

Weight:3.2kg



Price : (AUD)

EM-MA001 / RIGHT ENGINE MOUNT (Hydraulic) MAZDA
6 GG 2002-2008 OEM: GJ6G-39-060E

Dimension:160*115*115mm

Weight:2kg



Price : (AUD)

EM-TA001(3PCS) / Rubber Exhaust Mount suit Toyota
Landcruiser 40 60 75 78 80 Series # 17567-61030

Dimension:80*40*80mm

Weight:0.15kg



Price : (AUD)

EM-TA001(4PCS) / 4 x Toyota Landcruiser Rubber
Exhaust Mounts 40 50 60 70 80 100 Series

Dimension:160*115*115mm

Weight:1kg



Price : (AUD)

**EM-TA002 / Front Engine Mount Toyota Hilux 2L 3L 5L
4x4 LN106 LN111 LN130 LN167 LN172 2Pcs**

Dimension:165*115*115mm

Weight:1.5kg



Price : (AUD)

**EM-TA003 / Front Engine Mount Landcruiser HJ75 HJ60
2H Diesel Motor 12/84-90 Left / Right**

Dimension:150*115*105mm

Weight:1.4kg



Price : (AUD)

**GEARM-TA001 / Rear Engine Gearbox Mount Toyota
Hilux 3L LN106 LN106R Transmission Diesel 2.8L**

Dimension:175*165*65mm

Weight:1.3kg



Price : (AUD)

FC-BMW001 / BMW Fan Clutch 320i 323i 328i 330i 520i 528i 523i 530i Z3 X5 SUV M3 Coupe

**Dimension: /
Weight: /**



Price : (AUD)

FC-NS001 / Viscous Coupling Fan Clutch Nissan Patrol GQ GU Ford Maverick 4.2L Diesel TD42

**Dimension: 170*170*100mm
Weight: 2kg**



Price : (AUD)

FC-TA001 / TOYOTA Landcruiser Radiator Fan Clutch 78 105 Series HZJ78 HZJ79 HZJ105 1HZ 4.2L

**Dimension: 170*170*100mm
Weight: 1.82kg**



Price : (AUD)

FC-TA002 / Viscous Coupling Fan Clutch Toyota Landcruiser 75 80 Series HZJ75 HZJ80 1HZ 4.2L

**Dimension: 170*170*100mm
Weight: 2kg**



Price : (AUD)

**FC-TA003 / Toyota Radiator Fan Clutch Landcruiser
Prado VZJ95 V6 5VZ-FE Hilux LN106 LN111**

Dimension:/
Weight:1.8kg



Price : (AUD)

**RSA-HLN001 / 2 Rear Shocks Holden Astra TS Sedan &
Hatchback Shock Absorber 1998 - 2004**

Dimension:460*460*47mm
Weight:2kg



Price : (AUD)

**FSA-HLN001L+FSA-HLN001R / Holden Astra TS 2.2L
Convertible Front Struts Shock Absorbers 01-07 Sedan
Hatch**

Dimension:570*230*160mm
Weight:7kg



Price : (AUD)

**FUELC-SU001 / Fuel Cap for Suzuki LJ50 LJ80 Sierra
SJ410 SJ413 Maruti MG410 Holden Drover NB**

Dimension:75*75*30mm

Weight:0.15kg



Price : (AUD)

**FF-MB001 / Fuel Filter Daihatsu Isuzu Mazda Mitsubishi
Opel Suzuki Vauxhall Hyundai MB22090**

Dimension:100*100*145mm

Weight:0.4kg



Price : (AUD)

**DFP-HLN001 / Diesel Fuel Pump Rodeo TFR55 TFS55
Holden 4JB1-T 2.8L 1990-2002 Assembly 8mm**

**Dimension:250*130*110mm
Weight:0.7kg**



Price : (AUD)

**DFP-TA001 / Fuel Primer Pump Toyota Hilux LN106
LN107 LN111 LN56 LN86 Diesel 2.8L 3L 4cyl**

**Dimension:/
Weight:/**



Price : (AUD)

**DFP-TA002 / Landcruiser HZJ80 Diesel Fuel Primer
Pump Toyota 1HZ 80 Series 4.2L 23301-17150**

**Dimension:/
Weight:/**



Price : (AUD)

**FP-AUDI001 / Genuine Machter Universal Inline Fuel
Pump Audi 80 100 M-B 220 230 60mm Petrol**

**Dimension:230*230*70mm
Weight:0.07kg**



Price : (AUD)

FP-BOSH001 / Inline External Fuel Pump Group A
Holden Commodore VL Statesman Falcon 220 LPH

Dimension:200*70*65mm

Weight:0.06kg



Price : (AUD)

GP-FD001 / Courier PD PE PG PH 4 Glow Plugs Ford
Mazda B2500 WL-T Turbo Diesel 4cyl 2.5L

Dimension:120*180mm

Weight:0.1kg



Price : (AUD)

GP-MB001 / Heater Glow Plugs Triton MK K77T L200
Pajero NL 4M40 4M40T Mitsubishi 98-04

Dimension:120*180mm

Weight:0.1kg



Price : (AUD)

GP-NS001 / Glow Plugs Set OEM Fit Nissan Patrol GQ Y60 Genuine Macther TD42 Ford DA Diesel

Dimension:120*180mm

Weight:0.15kg



Price : (AUD)

GP-TA001 / Toyota Heater Glow Plug Landcruiser HJ60 82-88 HJ75 84-88 Diesel w/2H 4.0 Diesel

Dimension:120*180mm

Weight:0.15kg



Price : (AUD)

GP-TA002 / Diesel Glow Plugs Toyota Hilux 4Runner Surf LN130 3.8L 3L 2.4L 2L-T 1989-1996

Dimension:120*180mm

Weight:0.1kg



Price : (AUD)

GP-TA003 / Landcruiser HDJ80 Glow Plugs Toyota 80 Series Turbo Diesel 1HD-T 4.2L 1990-1994

Dimension:120*180mm

Weight:0.1kg

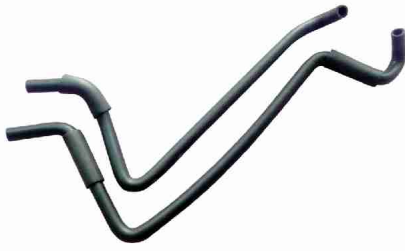

Price : (AUD)

HTH-NS001 / Heater Hose Set Patrol GQ Y60 Maverick
DA 4.2D TD42 6Cyl 1988-1997 92410-06J00

Dimension:460*460*50mm

Weight:0.65kg



Price : (AUD)

HVT-FD001 / Heater Valve Tap Ford Falcon Fairlane EA
EB ED EF EL AU 88-02 HA6315 V8 Engine

Dimension:/

Weight:/

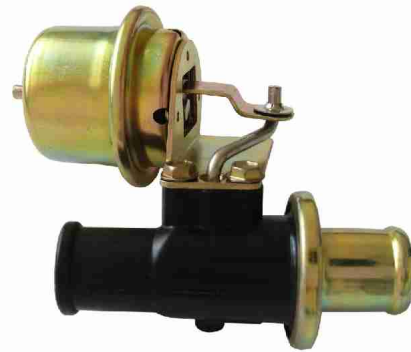

Price : (AUD)

HVT-FD002 / Heater Valve Tap Ford EA EB ED EF EL AU
DA DC DF DL NA NC NF NL 1988-2002 HV5213

Dimension:90*45*90mm

Weight:0.1kg



Price : (AUD)

HVT-HLN001 / Heater Valve Tap Holden Commodore V6
3.8L VX VU VY VN VP VR VS VT 4 Port 1988-04

Dimension:100*90*100mm

Weight:0.15kg



Price : (AUD)

HVT-HLN002 / Holden Commodore Heater Valve Tap VN
VP VR VT V8 Ford Falcon XD FC FE XF ZL 4.1L

Dimension:90*45*90mm

Weight:0.1kg



Price : (AUD)

HVT-HLN003 / Heater Valve Tap Holden Vectra JR JS 3
Port Sedan Ute Wagon 2.0L 2.2L 2.5L 2.6L

Dimension:/

Weight:/



Price : (AUD)

HVT-HLN004 / Heater Tap Valve suit Holden VZ WL
Berlina Commodore SV6 Alloytec V6 3.6L Vacuum

Dimension:/

Weight:/



Price : (AUD)

HVT-UNI001 / Heater Tap Valve Universal fit 16mm 5/8"
Cable Type Inline Car Hot Rod HV4008

Dimension:90*90*45mm

Weight:0.12kg



Price : (AUD)

ICV-HLN001 / Holden COMMODORE VR VS VT 3.6 V6 5.0
V8 Idle Air Speed Control Valve IAC ISC

Dimension:50*35*75mm

Weight:0.1kg



Price : (AUD)

ICV-HLN002 / Holden Idle Air Speed Control IAC ISC
Valve Commodore VT VX VY VZ 5.7L V8 GEN3

Dimension:50*35*75mm

Weight:0.1kg



Price : (AUD)

ICV-MB001 / Idle Air Speed Control Valve For Mitsubishi Pajero NM & NP 6G74 3.5L V6 IAC IAS

Dimension:85*60*65mm

Weight:0.1kg



Price : (AUD)

KS-HLN001 / Pair Knock Sensor Commdore Ute Statesman 5.7L & 6.0L V8 VT VX VY VZ 10456603

Dimension:75*65*65mm

Weight:0.2kg



Price : (AUD)

KS-NS001 / Knock Sensor for Nissan Navara D22 Pathfinder R50 3.3L VG33E 22060-7B000

Dimension:75*65*65mm

Weight:0.1kg



Price : (AUD)

KS-SR001 / Knock Sensor For Subaru Impreza WRX STi G11 Liberty Outback Forester 22060-AA070

Dimension:75*65*65mm

Weight:0.1kg



Price : (AUD)

**KS-TA001 / Toyota LandCruiser Knock Sensor FZJ75
FZJ80 92-99 4.5L 6CYL 1FZ-FE Lexus LX450**

Dimension:55*35*75mm

Weight:0.05kg



Price : (AUD)

**STEM-FD001 / Ford FALCON AU BA BF FG VIALLE
LPG Gas Converter Stepper Motor Controller**

Dimension:50*35*75mm

Weight:0.1kg



Price : (AUD)

**IC-BMW001 / New Ignition Coil Machter OEM Fit BMW
E39 E46 E53 E88 3 5 7 Series X3 X5 Z3 Z4**

Dimension:/

Weight:0.25kg



Price : (AUD)

**IC-BMW002 / BMW Ignition Coil OEM Fit 323 325 328 330
E39 E46 E53 3 5 7 Series 12131703227**

Dimension:410*195*100mm

Weight:2kg



Price : (AUD)

IC-FD001 / New Machter Ignition Coil Pack Ford Falcon
BA BF Fairlane LTD XR6 Territory SX

Dimension:385*145*65mm

Weight:1.25kg



Price : (AUD)

IC-FD001G / Ford Falcon Ignition Coil 6-pack BA BF
Fairlane Fairmont XR6 LTD Territory SX SY

Dimension:385*145*65mm

Weight:1.25kg



Price : (AUD)

IC-FD002 / Set of 2 Ingition Coils Mazda 323 BJ Ford
Laser KN KQ 1998-2003 ZMD 1.6L 4cyl

Dimension:200*100*70mm

Weight:0.6kg



Price : (AUD)

IC-FD003 / Ford Ignition Coil Pack AU2 AU3 Falcon
Fairlane Fairmont Mazda Petrol 4.0L 6cyl

Dimension:385*145*65mm

Weight:2kg



Price : (AUD)

IC-HD001 / Exhaust 4 Ignition Coils Honda Jazz GD GE 1.4L Civic VII 1.3L L13Z1 L13A1 LDA1

Dimension:385*145*65mm

Weight:1kg



Price : (AUD)

IC-HD002 / Ignition Coils for Honda Jazz GD GE 1.4L & Civic VII 1.3L L13A1 LDA1 Intake 4pcs

Dimension:385*145*65mm

Weight:1kg



Price : (AUD)

IC-HD003 / Honda 4 Ignition Coils Jazz II GD L15A 1.5L 4cyl 2002-2008 CM11-110 Hatchback

Dimension:235*200*80mm

Weight:0.95kg



Price : (AUD)

IC-HLN001 / TS AH Astra OEM Fit Holden Ignition Coil Pack 1.8L X18XE Z18XE 4cyl Petrol 98-07

Dimension:410*190*100mm

Weight:1.8kg



Price : (AUD)

IC-HLN002 / Holden Cruze Ignition Coil Pack JG JH Series F18D4 4Cyl 1.8L Petrol 09 onwards

Dimension:410*195*70mm

Weight:1.5kg



Price : (AUD)

IC-HLN003 / Ignition Coil for RodeoTF RA Holden Jackaroo Frontera UT 6VD1 6VE1 3.2L 3.5L 1pc

Dimension:/

Weight:/



Price : (AUD)

IC-HLN004 / Ignition Coil Holden Commodore VZ Adventura Rodeo Caprice WL Statesman Crewman

Dimension:/

Weight:/



Price : (AUD)

IC-HLN005 / New Holden Commodore Ignition Coil VN VP VR VS VT VX VT Statesman WH WK Express

Dimension:/

Weight:/



Price : (AUD)

IC-HLN006 / Ignition Coil Pack Holden Barina Combo XC Series Z14XE 1.4L Petrol 4cyl 1208307

Dimension:400*120*80mm

Weight:1.65kg



Price : (AUD)

IC-HLN007 / New Ignition Coil Pack for Holden Viva JF F18D 1.8L 4cyl 2005-2009 96415010

Dimension:410*195*100mm

Weight:1.25kg



Price : (AUD)

IC-HLN008 / Ignition Module Holden Commodore VN VP VR VS VT V8 Statesman VQ VR VS 5.0L Seden

Dimension:160*100*60mm

Weight:0.5kg



Price : (AUD)

IC-MA001 / Mazda & Ford 6 Ignition Coils Tribute MPV LW Mercury Escape BA ZA ZB 3.0L V6

Dimension:385*145*65mm

Weight:1.27kg



Price : (AUD)

IC-MA002 / OEM Quality Mazda RX8 4 Ignition Coil Pack
SE3P 1.3L ROTARY 13B 4cyl 2003-2012

Dimension:230*195*80mm

Weight:0.95kg



Price : (AUD)

IC-MA003 / Mazda & Ford Ignition Coil 323 BJ Laser KQ
Premacy CP MX5 NB FFY1-18-100 2pcs

Dimension:385*145*65mm

Weight:1kg



Price : (AUD)

IC-TA002 / Toyota Ignition Coil Echo Yaris Prius Hybrid
1NZ-FE 2NZ-FE 1.3L 1.5L Petrol 4cyl

Dimension:385*145*65mm

Weight:1kg



Price : (AUD)

IL-HLN001 / Holden Ignition Leads Spark Plug 8mm V6
Commodore VN VP VR VS VT VX VY 3.8L

Dimension:300*170*85mm

Weight:0.45kg

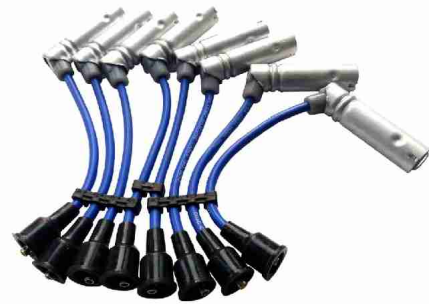

Price : (AUD)

IL-HLN002 / Holden V8 Ignition Spark Plug Leads
Commodore VT VU VX VY VZ 5.7L LS1 GEN3 22mm

Dimension:53*35*75mm

Weight:0.4kg



Price : (AUD)

INTERC-NS001 / INTERCOOLER NISSAN PATROL GU
ZD30 TURBO DIESEL 1997-2006 UPGRAD

Dimension:/

Weight:/



Price : (AUD)

INTERC-NS002 / Intercooler Upgrade For Nissan Patrol
Y61 ZD30 3.0L TD Pre 07

Dimension:/

Weight:/



Price : (AUD)

**INTERC-NS003 / Intercooler FOR NISSAN GU Patrol Rail
3.0L ZD30 turbo diesel 2007-2012**

Dimension:/
Weight: /



Price : (AUD)

**CV-6MM / 6mm 1/4" Alum. Alloy One Way Non-Return
Check Valve Petrol Diesel Water Fuel Oil**

Dimension:/
Weight:0.02kg



Price : (AUD)

**CV-8MM / 8mm 5/16" Aluminium Alloy One Way
Non-Return Check Valve Water Diesel Petrol Oil**

Dimension:/
Weight:0.02kg



Price : (AUD)

CV-10MM / 10mm 3/8" Aluminium Alloy One Way Non-Return Check Valve Petrol Diesel Oil Water

Dimension: /
Weight: 0.02kg



Price : (AUD)

CV-12MM / ALUMINIUM 12mm 1/2" ONE WAY NON RETURN CHECK VALVE Fuel/Diesel/Water/Marine/Oil

Dimension: /
Weight: 0.02kg



Price : (AUD)

ISS-HLN001 / HOLDEN COMMODORE VR VS VT VX INDICATOR STALK NO CRUISE BLINKER SWITCH 7 PINS

Dimension: 200*70*55mm
Weight: 0.15kg



Price : (AUD)

ISS-HLN002 / Holden VR VS VT VX1 Commodore Indicator Stalk/Switch with Cruise Control 7 ports

Dimension: 190*70*55mm
Weight: 0.15kg

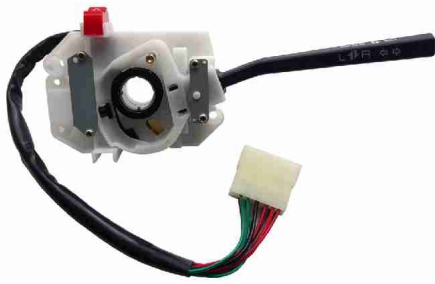

Price : (AUD)

ISS-HLN004 / Indicator High Beam Stalk Switch Blinker Turn Switch Holden Rodeo TF TFR TFS

Dimension:265*95*105mm

Weight:0.45kg



Price : (AUD)

ISS-TA001 / 1991-1997 Indicator Headlight Switch Wiper Blinker Stalk Hilux RN105 RN106 RN110

Dimension:395*110*95mm

Weight:0.6kg



Price : (AUD)

ISS-TA002 / COMBINATION HEADLAMP SWITCH SUIT TOYOTA COROLLA ZZE122 WITHOUT FOG LAMPS 01-07

Dimension:/

Weight:/



Price : (AUD)

BFMB-001 / Number Licence Plate Mount Bracket for LED Driving Light Bar Black Universal

Dimension:/
Weight: /



Price : (AUD)

BFMB-002 / Number Licence Plate Mount Bracket LED Driving Light Bar Silver Stainless Steel

Dimension: /
Weight: /



Price : (AUD)

BFMB-003 / NUMBER PLATE HOLDER MOUNT BRACKET CAR LED DRIVING LIGHT BAR SPOT LICENCE FRAME

Dimension: /
Weight: /



Price : (AUD)

**NUT-TA001 / Landcruiser Axle Adjusting Nut Front Hub
40 50 60 70 54mm Hilux Live 4x4 Washer**

Dimension:/
Weight:0.15kg

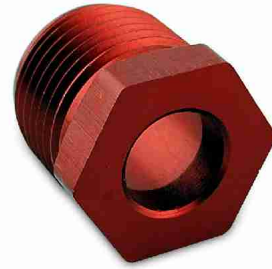

Price : (AUD)

**NUT-HD001 / Honda cable Billet Locker Nut AQUATRAX
Trim REVERSE ALUM NUT F15 R12 R12X F12X**

Dimension:/
Weight: /



Price : (AUD)

**NUT-SEAD001 / Seadoo Steering Cable Billet Locker Nut
Reverse Alum RXP RXT GTX 277000784 WAKE**

Dimension:/
Weight: /



Price : (AUD)

**ST-TA001 / Toyota Landcruiser Front Wheel Hub Axle
Nut 54mm Socket Kit Hilux 4wd 3/8"Drive**

Dimension:/
Weight:0.5kg



Price : (AUD)

ST-TA002 / Wheel Hub Nut Socket 54mm 1/2" Drive
Patrol Y60, GQ, MQ , MK Maverick DA 4WD

Dimension:/
Weight: /



Price : (AUD)

ST-TA003 / Toyota Landcruiser 1/2" Drive Rear Hub
Socket Axle Bearing Lock Nut 09509-25011

Dimension:/
Weight: /



Price : (AUD)

ST-NS001 / Hub Adjusting Socket Tool for Nissan Patrol
GQ GU Y61 Front Wheel Bearing Nut

Dimension:/
Weight: /



Price : (AUD)

STKIT-TA001 / Toyota 54mm Axle Nut Socket Kit for
Drive Hub wheel bearing Landcruiser Hilux

Dimension:/
Weight: /



Price : (AUD)

**BSA-NS001 / 2 Bonnet Bump Bumper Rubber Stop suits
Nissan Patrol GQ Y60 Ford Maverick 88-97**

**Dimension:/
Weight:/**



Price : (AUD)

**OILCAN-001 / Uni Pro 200 Oil Catch Can 4x4 Patrol
Diesel Landcruiser Hilux Navara Turbo Vent**

**Dimension:240*160*150mm
Weight:0.6kg**



Price : (AUD)

**OILCAN-001F / Pro Vent 200 Replacement Filter Element
Oil Catch Can 4WD 4X4 LC5001X 3931050950**

**Dimension:85*85*165mm
Weight:0.15kg**



Price : (AUD)

OILCAN-002 / Universal Oil Catch Can 4x4 Patrol Diesel Landcruiser Hilux Navara Pro 200 Turbo

Dimension:240*160*150mm

Weight:0.6kg



Price : (AUD)

OILCAN-002F / Pro Turbo 200 Replacement & Washable Stainless Filter Element Oil Catch Can 4wd

Dimension:85*85*165mm

Weight:0.25kg



Price : (AUD)

OILCAN-003 / Patrol GQ GU Uni Pro Vent Oil Catch Can Tank Crankcase 100KW Series Paper Filter

Dimension:115*165*115

Weight:0.35kg



Price : (AUD)

OILCAN-003SS / Oil Catch Can Crankcase Stainless Filter GQ GU Patrol Pro 100KW 2 x 3/4 inch

Dimension:115*165*115

Weight:0.35kg



Price : (AUD)

**OILCAN-004 / Small 19mm Oil Catch Can Tank
Crankcase Breather Vent Pro Patrol Navara Hilux**

Dimension:115*165*115

Weight:0.35kg



Price : (AUD)

**OILCAN-004SS / Universal Small Oil Catch Can Tank
Crankcase Pro Patrol Hilux Navara 4x4 4WD**

Dimension:115*165*115

Weight:0.35kg



Price : (AUD)

**OCT-BLACK / Billet Aluminum Car Racing Engine Oil
Catch Tank Can Reservoir Black Round Hose**

Dimension:200*160*100mm

Weight:1.05kg



Price : (AUD)

**OCT-BLUE / 1L SQUARE G-STYLE BILLET OIL CATCH
TANK/CAN ALUMINUM ENGINE RESERVOIR BREATHER**

Dimension:120*110*205mm

Weight:1.05kg



Price : (AUD)

**OCT-RED / Uni Aluminum Racing Oil Catch Can Tank
Reservoir Billet RED Round Turbo Most Car**

Dimension:160*100*205mm

Weight:1.05kg



Price : (AUD)

**OPS-HLN001 / Holden Commodore V6 VZ VE Oil
Pressure Sensor Switch 12621649 3.6L LEO LY7 Rodeo**

Dimension:34*34*60mm

Weight:0.05kg



Price : (AUD)

**OPS-HLN002 / Oil Pressure Switch Sensor Holden
Commodore VT VX VY VZ VE V8 5.7 6.0 6.2**

Dimension:34*34*70mm

Weight:0.05kg



Price : (AUD)

OPS-HLN003 / Holden Commodore VT Statesman WH WK 3.8L V6 Oil Pressure Switch Sensor 25036853

Dimension:34*34*60mm

Weight:0.05kg



Price : (AUD)

OPS-HLN004 / Oil Rail Pressure Sensor Holden Jackaroo UBS 4JX1 ORPS 97137042 - ISUZU TD

Dimension:75*65*65mm

Weight:0.2kg



Price : (AUD)

OP-HLN001 / Rear Main Oil Seal & Plate Housing HOLDEN STATESMANWH WK WL WM WN V8 Brand New

Dimension:/

Weight:/



Price : (AUD)

BPS-BATT001 / Toyota Push Rocker Switch LED Light Bar Prado Hilux Landcruiser 4 Runner ON OFF

Dimension: /
Weight:0.035kg



Price : (AUD)

BPS-COMP001 / Push Rocker Dash Light Switch Replacement Hilux Prado Landcruiser 4Runner 12V 3A Push Switch

Dimension: /
Weight:0.035kg



Price : (AUD)

BPS-DRI001 / Toyota Landcruiser Push Switch LED SPOT WORK DRIVING Prado 120 Hilux Highlander

Dimension: /
Weight:0.035kg



Price : (AUD)

BPS-DRI002 / Toyota Landcruiser Push Switch LED SPOT WORK DRIVING Prado 120 Hilux Highlander

Dimension: /
Weight:0.035kg



Price : (AUD)

BPS-FOG001 / Toyota Push Rocker Switch LED Light Bar Prado Hilux Landcruiser 4 Runner ON OFF

Dimension:/
Weight:0.035kg



Price : (AUD)

BPS-FOG002 / Toyota Landcruiser Push Switch LED SPOT WORK DRIVING Prado 120 Hilux Highlander Push Switch

Dimension:/
Weight:0.035kg



Price : (AUD)

BPS-FRI001 / Push Switch LED SPOT WORK DRIVING Toyota Landcruiser Prado 120 Hilux Highlander

Dimension:/
Weight:0.035kg



Price : (AUD)

BPS-LED001 / Blue LED Light Bar Push Switch Toyota Landcruiser Prado Hilux Replacement Car

Dimension:/
Weight:0.035kg



Price : (AUD)
 BPS-LED002 / Green LED Light Push Switch Bar Toyota
 Landcruiser Prado 120 Hilux Car Boat 12V

Dimension:/
 Weight:0.035kg



Price : (AUD)
 BPS-LED003 / LED Light Bar Push Switch Toyota
 Landcruiser Prado 120 Hilux 4Runner Dual Orange

Dimension:/
 Weight:0.035kg



Price : (AUD)
 BPS-REAR001 / Push Switch Rear Lights Toyota
 Landcruiser Prado 120 Hilux Car Boat Blue ON OFF

Dimension:/
 Weight:0.035kg



Price : (AUD)
 BPS-REAR002 / Green LED Rear Light Push Switch
 Toyota Landcruiser Prado 120 Hilux Laser Etched

Dimension:/
 Weight:0.035kg



Price : (AUD)
BPS-REVL001 / Push Switch Reverse Lights Toyota Landcruiser Prado 120 Hilux Car Boat Blue 12V Push Switch
 Dimension:/
 Weight:0.035kg



Price : (AUD)
BPS-SPOT001 / Laser Blue LED Spot Light On-Off Switch Landcruiser Hilux Prado Tacoma 12V
 Dimension:/
 Weight:0.035kg



Price : (AUD)
BPS-SPOT002 / Orange led Spot Lights Push Switch Dual Landcruiser Prado Hilux Laser Etched
 Dimension:/
 Weight:0.035kg



Price : (AUD)
BPS-SPTI001 / Spotties Light Push Switch Dual Blue Landcruiser Prado Hilux Laser Etched
 Dimension:/
 Weight:0.035kg



Price : (AUD)

BPS-REVC001 / Toyota Push Rocker Switch LED Light Bar Prado Hilux Landcruiser 4 Runner ON OFF Push Switch

Dimension: /
Weight: 0.035kg



Price : (AUD)

BPS-TRAY001 / Push Switch Tray Lights Dual Blue Toyota Landcruiser Prado Hilux Laser Etched

Dimension: /
Weight: 0.035kg



Price : (AUD)

BPS-WINCH001 / Push Switch Winch Power Dual Green Toyota Landcruiser Prado Hilux Laser Etched

Dimension: /
Weight: 0.035kg



Price : (AUD)

BPS-WINCH002 / Push Switch Winch Power Toyota Landcruiser 75 Prado 120 Hilux FJ Cruiser ON OFF

Dimension: /
Weight: 0.035kg



Price : (AUD)

BPS-WORK001 / Prado Hilux Work Lights Push Rocker Switch Blue Landcruiser Car Boat AU Stock

Dimension:/
Weight:0.035kg



Price : (AUD)

LRS-BUMPER001 / Blue LED Laser Etched Carling Type Rocker Switch 20Amp 12V Waterproofing Design

Dimension:/
Weight:0.035kg



Price : (AUD)

LRS-AIR001 / Lase Etched Rocker Switch Air Compressor RED LED ARB Carling Narva 12V 24V Boat

Dimension:/
Weight:0.035kg



Price : (AUD)

LRS-INTER001 / Blue LED Laser Etched Carling Type Rocker Switch 20Amp 12V Waterproofing Design

Dimension:/
Weight:0.035kg



Price : (AUD)

LRS-LED001 / Laser Etched Rocker Switch LED Light Bar Dual Red ARB Carling 12V 24V ON OFF AU

Dimension:/
Weight:0.035kg



Price : (AUD)

LRS-LED002 / Laser Etched Rocker Switch Dual Orange LED Light Bar Carling Style 12V 24V Boat

Dimension:/
Weight:0.035kg



Price : (AUD)

LRS-REAR001 / Laser Etched Rocker Switch REAR LIGHTS Dual Blue LED 12V 24V Boat ON OFF Backlit

Dimension:/
Weight:0.035kg



Price : (AUD)

LRS-REAR002 / Laser Etched Rocker Switch Rear Lights Dual Red ARB Carling Narva 12V 24V ON OFF

Dimension:/
Weight:0.035kg



Price : (AUD)

LRS-REAR003 / Laser Rocker Switch Finger Rear Lights
Blue Led Light On-Off 20A 12V Truck Car

Dimension: /
Weight:0.035kg



Price : (AUD)

LRS-REVS001 / Reverse Camera Rocker Switch Laser
Etched Dual Blue LED ARB Carling 12V 24V Boat

Dimension: /
Weight:0.035kg



Price : (AUD)

LRS-WINCH001 / Laser Etched Rocker Switch Winch
Power Dual Red ARB Carling 12V 24V ON OFF Boat

Dimension: /
Weight:0.035kg



Price : (AUD)

LRS-WINCH002 / Laser Etched Rocker Switch ARB
Carling Dual Winch Power 12V 24V Boat ON OFF

Dimension: /
Weight:0.035kg



Price : (AUD)

LRS-ZOMB001 / Laser Etched Rocker Switch Zombie Lights 12V 24V Green Red ARB Carling ON OFF

Dimension:/
Weight:0.035kg



Price : (AUD)

MBPS-LED001R / Mitsubishi Push Switch LED LIGHT BAR LED Red Pajero Triton Challenger Evo 3A 12V

Dimension:/
Weight:0.035kg



Price : (AUD)

MBPS-LED002B / 12V 3A Push Switch LED LIGHT BAR LED Amber BLUE on off Mitsubishi Pajero Triton

Dimension:/
Weight:0.035kg



Price : (AUD)

MBPS-SPOT001R / Mitsubishi Push Switch SPOT LIGHTS LED Red Pajero Triton Challenger Evo 3A 12V

Dimension:/
Weight:0.035kg



Price : (AUD)

MBPS-SPOT002B / Mitsubishi Push Switch SPOT LIGHTS LED Blue Pajero Triton Challenger Evo 3A 12V

Dimension: /
Weight: 0.035kg



Price : (AUD)

NSPS-AIR001Y / Nissan Push Switch AIR COMP Yellow Pathfinder Navara D40 Patrol X-Trail 3A 12V

Dimension: /
Weight: 0.035kg



Price : (AUD)

NSPS-DRIV001Y / Nissan Push Switch DRIVING LIGHTS Yellow Pathfinder Navara D40 Patrol Y62 3A 12V

Dimension: /
Weight: 0.035kg



Price : (AUD)

NSPS-LED001Y / Push Switch 12V LED LIGHTS ON OFF YELLOW Nissan Patrol Pathfinder Navara 12V 3A

Dimension: /
Weight: 0.035kg



Price : (AUD)
 NSPS-REAR001Y / Nissan Push Switch REAR LIGHT
 Yellow Pathfinder Navara D40 Patrol X-Trail 3A 12V

Dimension: /
 Weight: 0.035kg



Price : (AUD)
 NSPS-REVS001Y / Nissan Push Switch REVERSE
 LIGHTS Yellow Pathfinder Navara D40 Patrol XTrail 12V

Dimension: /
 Weight: 0.035kg



Price : (AUD)
 NSPS-SPOT001Y / Nissan Push Switch SPOT LIGHT
 Yellow Pathfinder Navara D40 Patrol X-Trail 3A 12V

Dimension: /
 Weight: 0.035kg



Price : (AUD)
 PS-AIR001 / Push Switch AIR COMP Toyota Prado 150
 200 Landcruiser Hilux RAV4 ON OFF 12V Blue

Dimension: /
 Weight: 0.035kg



Price : (AUD)

PS-CAM001 / Push Switch Toyota Prado 150 200 Landcruiser 200 RAV4 LED Light Bar 12V ON OFF rocker switch

Dimension: /

Weight:0.035kg



Price : (AUD)

PS-COMP001 / Push Switch Compressor Toyota Prado 150 200 Landcruiser RAV4 Green Red ON OFF

Dimension: /

Weight:0.035kg



Price : (AUD)

PS-DRI001 / Push Switch Driving Lights Toyota Landcruiser Prado 150 200 RAV4 Green Red 12V

Dimension: /

Weight:0.035kg



Price : (AUD)

PS-DRI002 / Push Switch Driving Lights Toyota Landcruiser Prado 150 200 RAV4 Blue ON OFF 12V

Dimension: /

Weight:0.035kg



Price : (AUD)

PS-DRI003 / Push Switch Driving Lights Toyota Landcruiser RAV4 Prado 150 200 Green ON OFF

Dimension: /
Weight:0.035kg



Price : (AUD)

PS-DRI004 / Push Switch Driving Lights Toyota Landcruiser 200 RAV4 Prado 150 200 Orange 12V

Dimension: /
Weight:0.035kg



Price : (AUD)

PS-FOG001 / Push Switch Toyota Prado 150 200 Landcruiser 200 RAV4 LED Light Bar 12V ON OFF rocker switch

Dimension: /
Weight:0.035kg



Price : (AUD)

PS-FRID001 / LED Light Bar Push Rocker Switch Toyota Hilux RAV4 Landcruiser Prado 150 12V 3A rocker switch

Dimension: /
Weight:0.035kg



Price : (AUD)
 PS-LED001 / LED Light Bar Push Rocker Switch Toyota Hilux RAV4 Landcruiser Prado 150 12V 3A rocker switch
 Dimension:/
 Weight:0.035kg



Price : (AUD)
 PS-LED002 / Push Switch LED Light Bar Toyota Landcruiser Prado 150 200 Hilux ON OFF Green rocker switch
 Dimension:/
 Weight:0.035kg



Price : (AUD)
 PS-LED003 / Push Switch LED Light Bar Toyota Landcruiser Prado 150 200 RAV4 Green Red ON OFF
 Dimension:/
 Weight:0.035kg



Price : (AUD)
 PS-LED004 / Push Switch LED Light Bar Toyota Prado 150 200 Landcruiser RAV4 Red 12V ON OFF
 Dimension:/
 Weight:0.035kg



Price : (AUD)

PS-LED005 / Push Switch Blue LED Light Bar RAV4
Landcruiser 200 Prado 150 200 12V 3A ON OFF

Dimension: /
Weight: 0.035kg



Price : (AUD)

PS-REAR001 / Push Switch Rear Lights Toyota
Landcruiser Prado 150 200 RAV4 Blue 12V ON OFF

Dimension: /
Weight: 0.035kg



Price : (AUD)

PS-REVS001 / Push Switch Reverse Lights Toyota
Landcruiser Prado 150 200 RAV4 12V Green Red

Dimension: /
Weight: 0.035kg



Price : (AUD)

PS-SPOT001 / Push Switch Spot Lights Toyota
Landcruiser Prado 150 200 RAV4 Blue 12V ON OFF

Dimension: /
Weight: 0.035kg



Price : (AUD)
 PS-SPOT002 / Push Switch Spot Lights Toyota Prado
 150 200 Landcruiser RAV4 Green 12V ON OFF

Dimension: /
 Weight: 0.035kg



Price : (AUD)
 PS-SPTS001 / Push Switch Spotties Toyota Landcruiser
 Prado 150 200 RAV4 Green Red 12V ON OFF

Dimension: /
 Weight: 0.035kg



Price : (AUD)
 PS-SPTS002 / Push Switch Spotties Toyota Prado 150
 200 RAV4 Landcruiser ON-OFF Laser Etched

Dimension: /
 Weight: 0.035kg



Price : (AUD)
 PS-TRAY001 / Push Switch Tray Lights Toyota
 Landcruiser Prado 150 200 RAV4 Green Red ON OFF

Dimension: /
 Weight: 0.035kg



Price : (AUD)

PS-USB001 / Push Switch USB Blue Toyota
Replacement Hilux RAV4 Landcruiser Prado 150 200 12V

Dimension:/
Weight:0.035kg



Price : (AUD)

PS-WORK001 / Push Switch Work Lights Toyota
Landcruiser 200 Prado 150 Hilux Blue 12V ON OFF

Dimension:/
Weight:0.035kg



Price : (AUD)

RS-AUXI001 / ARB ROCKER SWITCH AUX BATTERY
CARLING NARVA DUAL BLUE LED BACKLIT ON OFF 12V
24V

Dimension:/
Weight:0.035kg



Price : (AUD)

RS-AUXY001 / ARB AUXILLARY BATTERY ROCKER
ON/OFF SWITCH BLUE LED BACKLIT 4X4 Car Boat 12V
24V

Dimension:/
Weight:0.035kg



Price : (AUD)
RS-BUNNY001 / BUNNY BURNERS NARVA ARB CARLING ROCKER SWITCH LIGHTS BLUE LED ON/OFF Car Boat
 Dimension:/
 Weight:0.035kg



Price : (AUD)
RS-COMP001 / ARB ROCKER SWITCHES COMPRESSOR LIGHTS DUAL BLUE LED BAR Car 12V ON OFF CARLING
 Dimension:/
 Weight:0.035kg



Price : (AUD)
RS-DRIV001 / ARB CARLING ROCKER SWITCH DRIVING LIGHTS DUAL BLUE LED ON OFF Car Boat 12V 24V
 Dimension:/
 Weight:0.035kg

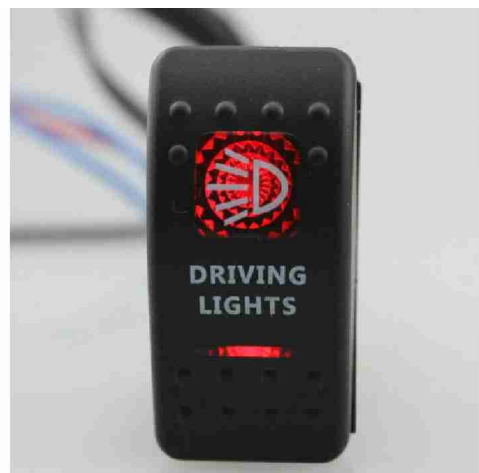

Price : (AUD)
RS-DRIV001RED / ARB ROCKER SWITCH CARLING NARVA DRIVING LIGHT DUAL RED BACKLIT ON OFF 12V 24V
 Dimension:/
 Weight:0.035kg



Price : (AUD)

RS-ENFAN001 / ARB CARLING NARVA ROCKER SWITCH ENGINE FAN DUAL BLUE LED ON OFF Car Boat 12V 24V

Dimension: /

Weight: 0.035kg



Price : (AUD)

RS-FOG001 / ARB ROCKER SWITCH FOG LIGHTS NARVA CARLING DUAL BLUE LED BACKLIT ON/OFF 12V 24V

Dimension: /

Weight: 0.035kg



Price : (AUD)

RS-FRID001 / ARB STYLE LED BACKLIT ROCKER SWITCH BLUE LED CARLING FRIDGE Toggle Switch 12V

Dimension: /

Weight: 0.035kg



Price : (AUD)

RS-LED001 / ARB Carling Narva Rocker Switch LED LIGHT BAR Dual BLUE LED 12V 24V Car Boat

Dimension: /

Weight: 0.035kg



Price : (AUD)

RS-LED001GREEN / ARB ROCKER SWITCHES LED LIGHT BAR CARLING DUAL GREEN LED ON OFF Car Boat 12V 24V

Dimension:/
Weight:0.035kg



Price : (AUD)

RS-LED002 / LED LIGHT BAR CARLING NARVA ARB ROCKER SWITCH DUAL RED ON/OFF 12V 24V Car Boat

Dimension:/
Weight:0.035kg



Price : (AUD)

RS-LEFT001 / ARB CARLING ROCKER SWITCH LEFT SIDE LIGHTS DUAL BLUE LED ON OFF Car Boat 12V 24V

Dimension:/
Weight:0.035kg



Price : (AUD)

RS-MON001 / Winch In/Out Momentary Rocker Switch ARB Lightforce Nissan GU GQ 80 Hilux Jeep

Dimension:/
Weight:0.035kg



Price : (AUD)

RS-MUSIC001 / Rocker Switch Music ARB Carling Narva
Dual Blue LED 12V 24V ON OFF Car Boat

Dimension: /
Weight: 0.035kg



Price : (AUD)

RS-NLED001 / Laser Etched LED Light Bar Rocker
Switches Backlit DUAL BLUE LED 12V 20A ON/OFF

Dimension: /
Weight: 0.035kg



Price : (AUD)

RS-NSPOT001 / LASER ETCHED SPOT LIGHT ROCKER
SWITCH WORK LIGHT BAR 4WD UTE 12V 24V CARLING

Dimension: /
Weight: 0.035kg



Price : (AUD)

RS-OFFROAD001 / ARB CARLING ROCKER SWITCH
OFF ROAD LIGHTS DUAL BLUE LED ON OFF Car Boat
12V 24V

Dimension: /
Weight: 0.035kg



Price : (AUD)

RS-ROOF001 / ARB ROCKER SWITCH ROOF LIGHTS CARLING NARVA DUAL BLUE LED BACKLIT ON/OFF 12V 24V

Dimension: /

Weight: 0.035kg



Price : (AUD)

RS-REAR001 / ARB Carling Narva Rocker Switch REAR LIGHT Blue LED 4x4 4WD 12V 24V Car Boat

Dimension: /

Weight: 0.035kg



Price : (AUD)

RS-REAR001RED / ARB CARLING NARVA ROCKER SWITCH REAR LIGHTS DUAL RED LED ON OFF Car Boat 12V 24V

Dimension: /

Weight: 0.035kg



Price : (AUD)

RS-REAROFF001 / ARB CARLING ROCKER SWITCH REAR ROOF LIGHT DUAL BLUE LED BACKLIT ON OFF 12V 24V

Dimension: /

Weight: 0.035kg



Price : (AUD)

RS-REVS001 / Rocker Switch ARB Carling Narva Dual Blue Led Reverse Lights Car Boat 12V ON OFF

Dimension:/
Weight:0.035kg



Price : (AUD)

RS-REVS002 / ARB ROCKER SWITCH REVERSE CAMERA CARLING NARVA DUAL BLUE LED BACKLIT ON/OFF 12V

Dimension:/
Weight:0.035kg



Price : (AUD)

RS-RIGHT001 / ARB ROCKER SWITCH RIGHT SIDE LIGHTS CARLING DUAL BLUE LED BACKLIT ON OFF 12V 24V

Dimension:/
Weight:0.035kg



Price : (AUD)

RS-SPOT001ORA / ARB CARLING ROCKER SWITCHES SPOT LIGHTS DUAL ORANGE LED ON OFF Car Boat 12V 24V

Dimension:/
Weight:0.035kg



Price : (AUD)

RS-SPOTTIE001 / ARB ROCKER SWITCH SPOTTIES
CARLING NARVA DUAL BLUE LED BACKLIT ON OFF 12V
24V

Dimension: /

Weight: 0.035kg



Price : (AUD)

RS-SPOT001 / ARB Rocker Switch SPOT LIGHTS Narva
Carling ON/OFF Blue LED 12V 24V 4WD Car Boat

Dimension: /

Weight: 0.035kg



Price : (AUD)

RS-TRAY001 / ARB Rocker Switch Tray Lights Carling
Narva 12V 24V Dual Blue Backlit ON/OFF

Dimension: /

Weight: 0.035kg



Price : (AUD)

RS-WINCH001 / WINCH ISOLATOR NARVA ARB
CARLING ROCKER SWITCH LIGHTS BLUE LED ON/OFF
Car Boat

Dimension: /

Weight: 0.035kg



Price : (AUD)

RS-WINPOWER / ARB CARLING NARVA ROCKER SWITCH WINCH POWER DUAL BLUE LED ON OFF Car Boat 12/24V

Dimension: /

Weight: 0.035kg



Price : (AUD)

RS-ZOMB001 / ARB Rocker Switch Zombie Lights Carling Narva ON OFF Dual Blue Backlit 12V 24V

Dimension: /

Weight: 0.035kg



Price : (AUD)

USB-ST001 / Blue LED Rocker Switch USB Charger Panel Dual 2 Port Carling Socket Car 5V 3.1A

Dimension: /

Weight: 0.035kg



Price : (AUD)

USB-TA001 / USB Charger Switch Dual Blue Prado 120 Hilux LC 75-100 4Runner FJ Cruiser Tacoma

Dimension: /

Weight: 0.035kg



Price : (AUD)
 USB-TA002 / Dual USB Charger Switch Toyota Prado
 120 Hilux LC75-100 FJ Cruiser Highlander

Dimension:/
 Weight:0.035kg



Price : (AUD)
 FSKIT-TA001 / Hilux 4x4 LN165 LN166 LN170 LN192
 Toyota Ball Joint Tie Rod End Idler Pitman Arm

Dimension:/
 Weight: /



Price : (AUD)
 PA-TA001 / Hilux IFS 4X4 Pitman Arm Toyota LN167
 LN172 RZN169 RZN174 1997-2005 Right Hand

Dimension:/
 Weight: /



Price : (AUD)

PIARM-TA001 / Steering Idler Pitman Arm Toyota Hilux
LN167 LN172 KZN165 RZN169 VZN167 4x4 IFS

Dimension:/
Weight: /



Price : (AUD)

SIA-TA001 / Idler Arm Steering Joint Toyota IFS Hilux
LN167 LN172 KZN165 RZN169 VZN167 4WD

Dimension: /
Weight: /



Price : (AUD)

PSK-TA001 / Power Steering Box Seal Kit Toyota
Landcruiser 80 Series FJ80 FZJ80 HDJ80 HZJ80

Dimension: 210*135*68mm
Weight: 0.05kg



Price : (AUD)

**PSP-HD001 / Honda Accord Euro Power Steering Pump
03-07 2.4L 4 Cyl K24A Accord US 06-08**

**Dimension:/
Weight:/**



Price : (AUD)

**PSP-HLN001 / Power Steering Pump Holden
Commodore 5.7 LITRE Gen 3 LS1 V8 VT VX VU VY WH
WK WL**

**Dimension:225*180*180mm
Weight:3.75kg**



Price : (AUD)

**PSP-HLN002 / HOLDEN COMMODORE V8 VG VQ VN VP
VR VS POWER STEERING PUMP BRAND NEW**

**Dimension:225*180*180mm
Weight:4.1kg**



Price : (AUD)

**PSP-TA002 / Fit Toyota Land Cruiser 80 Series HZJ75
4.2 1HD 1HDFT Diesel Power Steering Pump**

**Dimension:225*180*180mm
Weight:4.1kg**



Price : (AUD)

PSR-TA001 / Toyota Hilux KUN26 GGN25 4WD SR5
Power Steering Rack Pinion w/ Tie Rod Ends

Dimension:1325*245*145mm

Weight:11.4kg



Price : (AUD)

PSR-TA002 / POWER STEERING RACK FOR TOYOTA
LANDCRUISER PRADO KZJ95 VZJ95 RZJ95 90 95
SERIES

Dimension:980*230*170mm

Weight:12.3kg



Price : (AUD)

PSR-TA001-TRE / Tie Rod Ends Toyota Hilux KUN26
GGN25 KUN25 TGN26 4x4 Outer Front Left & Right

Dimension:/

Weight:/



Price : (AUD)

**PSRB-FD001 / Power Steering Rack Rubber Boot Holden
Commodore VT VX VY VZ WH WK WL 97-04 All**

Dimension:190*140*80mm

Weight: /



Price : (AUD)

**ROB-SU001 / Overflow Bottle for Suzuki Sierra SJ410
SJ40 SJ413 SJ50 SJ80 SJ70 Maruti MG410**

Dimension:200*100*95mm

Weight:0.3kg



Price : (AUD)

RAD-MA001 / Ford Courier Mazda Bravo Heavy Duty Radiator 1996-2006 Manual 34mm thick core

Dimension:700*140*640mm

Weight:5.45kg



Price : (AUD)

RAD-MB001 / MK Triton Radiator MANUAL Mitsubishi V6 3.0L 6Cyl 1996-2006 Aluminium Core

Dimension:375*598*260mm

Weight:5kg



Price : (AUD)

RAD-MB002 / MK Triton Radiator Auto Mitsubishi 96-06 6Cyl 3.0L V6 Aluminium Alloy Heavy Duty

Dimension:375*598*260mm

Weight:5kg



Price : (AUD)

FB-NS001 / Radiator Fan Blade Navara D21 D22 Engine Cooling Terrano II R20 TD27 TD27Ti 2.7L

Dimension:460*460*47mm

Weight:1kg



Price : (AUD)

FB-NS002 / Navara D21 TD27 Engine Fan Blade Electric Radiator Diesel 1995-02/1997 cooling

Dimension:460*460*47mm

Weight:1kg



Price : (AUD)

FB-NS003 / OEM QUALITY ENGINE FAN BLADE FOR NISSAN PATROL COMMON RAIL ZD30 3.0L 03/07-2014

Dimension:460*460*47mm

Weight:1kg



Price : (AUD)

FB-NS004 / FAN BLADE FIT NISSAN PATROL GQ Y60 TD42 4.2 DIESEL

Dimension:460*460*50mm

Weight:0.9kg



Price : (AUD)

FB-NS005 / Nissan Engine Cooling Fan Blade Patrol GQ
Y60 Maverick DA 1988-99 TD42 Diesel

Dimension:460*460*50mm

Weight:0.9kg



Price : (AUD)

FB-TA001 / Fan Blade suit Landcruiser 6cyl 4.2L 1HZ
1HD-FT 1HD-T & 5cyl 3.5L 1PZ Engine

Dimension:465*460*85mm

Weight:1.3kg



Price : (AUD)

FB-TA002 / Toyota Dyna Truck Engine Radiator Fan
Blade LY61 Hilux 4 Runner Diesel

Dimension:460*460*47mm

Weight:0.95kg

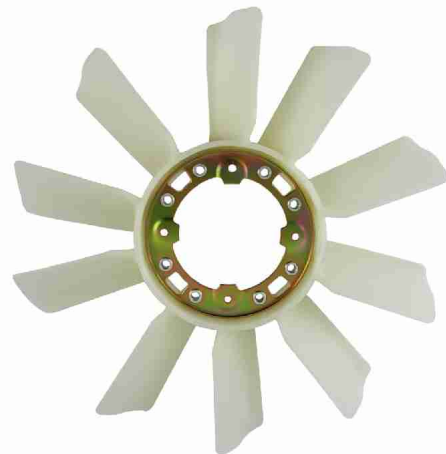

Price : (AUD)

FB-TA003 / Engine Fan Blade Toyota Hilux Surf
KZN130R 1993-1995 4cyl 1KZ-TE 3.0L Diesel

Dimension:/

Weight:/



Price : (AUD)

RBC-TA001L&RBC-TA001R / 2 Toyota Rear Disc Brake Caliper Landcruiser VDJ76 VDJ78 VDJ79 V8 Left Right NEW

Dimension:220*160*270mm

Weight:7.25kg



Price : (AUD)

RBC-TA002L+RBC-TA002R / 2 Front Brake Calipers Toyota Hilux LN106 LN107 LN111 RN105 RN106 RN110 RN130

Dimension:290*190*120mm

Weight:5.25kg



Price : (AUD)

RKS-FD002 / Remote Key Shell Case Ford 4 Button Falcon BA BF Territory SX XR6 XR8 FPV

Dimension:/

Weight:/



Price : (AUD)
**SNOK-NS003 / Nissan Patrol GQ Snorkel Kit Y60 Ford
 Maverick Diesel TD42 TB42 RB30 4WD 88-97**

Dimension:440*160*1510mm
Weight:/



Price : (AUD)
**SP-FD001 / Ford Falcon Spark Plugs For BA XR6
 Territory SX 4.0L Petrol 6cyl AGSP32Z 6pcs**

Dimension:/
Weight:/



Price : (AUD)
**SP-FD002 / Spark Plugs Ford Falcon BF FG 4.0L LPG
 Territory SY 0.7mm AGSP22YE07 Pack of 6**

Dimension:/
Weight:/

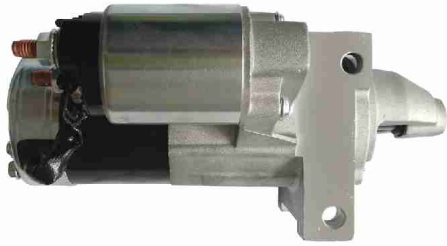

Price : (AUD)

SMOTOR-HLN001 / Commodore Starter Motor Holden V8 LS1 GEN3 GEN4 VT VX VY VZ VE SS 5.7L 99 - 04

Dimension:260*140*125mm

Weight:3.4kg



Price : (AUD)

SMOTOR-HLN002 / Starter Motor Fits Holden Rodeo TF 4WD Diesel 2.8L 4JB1T & 2.5L 4JA1 1988-2004

Dimension:280*160*125mm

Weight:5.45kg



Price : (AUD)

SMOTOR-HLN004 / Starter Motor Holden Adventra Commodore VZ VE 3.6L Petrol V6 HF Statesman WL WM

Dimension:260*142*125mm

Weight:3.6kg

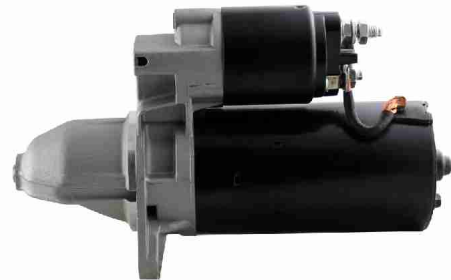

Price : (AUD)

SMOTOR-LR001 / Starter motor for Land Rover Discovery V8 3.5L 3.9L 4.0L Petrol Series 1 2 3

Dimension:275*175*110mm

Weight:4.7kg

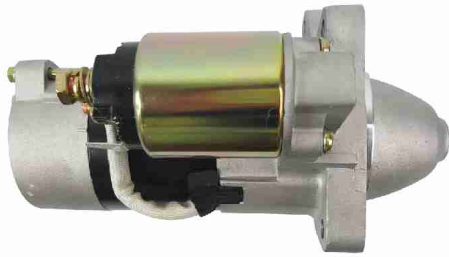

Price : (AUD)

**SMOTOR-MA001 / Starter Motor for Ford Courier PD PE
PG PH Ranger PJ PK Mazda Bravo B2500 WL WLT**

**Dimension:/
Weight: /**



Price : (AUD)

**SMOTOR-NS001 / Nissan Patrol Starter Motor GQ GU
TD42 TD45 TD48 4.2L 4.5L 4.8L Diesel 88-07**

**Dimension: /
Weight: /**



Price : (AUD)

**SMOTOR-NS002 / Nissan Starter Motor Navara D21 D22
2.5L 2.7L 3.0L 3.2L TD24 TD25 TD27 ZD30 QD32**

**Dimension:246*137*175mm
Weight:6.2kg**



Price : (AUD)

**SMOTOR-TA001 / Toyota Starter Motor suit Hilux KUN16
KUN26 D4D Prado KDJ120 1KD-FTV 3.0L Diese**

**Dimension:285*160*150mm
Weight:5.95kg**



Price : (AUD)

**SMOTOR-TA002 / Toyota Landcruiser Starter Motor
HJ47 HJ60 HJ61 HJ75 Eng 2H 12HT 4.0L Diesel**

**Dimension:/
Weight:/**



Price : (AUD)

**SMOTOR-TA003 / TOYOTA Hilux Starter Motor LN86
LN106 LN106R LN107 LN111 L 2L 3L 5L Diesel**

**Dimension:/
Weight:/**



Price : (AUD)

**SMOTOR-TA006 / Starter Motor to fit Toyota Landcruiser
HZJ80 HZJ79 HZJ78 HZJ75 with 4.2L diesel**

**Dimension:/
Weight:/**



Price : (AUD)

SM-FD001 / FRONT SUSPENSION STRUT TOP MOUNT + BEARING KIT VW Golf MK III FORD Galaxy 95-06

Dimension:120*120*60mm

Weight:0.78kg



Price : (AUD)

SM-HLN001 / Strut Mount & Bearing Kit Holden Crewman Ute VU VY VZ Commodore Top Rubber Bush

Dimension:210*135*68mm

Weight:1.28kg



Price : (AUD)

SM-HLN001B / Holden Strut Top Mount Bearing Commodore VR VS VT VU VX VY VE Statesman WH

Dimension:210*135*68mm

Weight:0.5kg



Price : (AUD)

DB-NS001 / Engine Drive Belt for Nissan Patrol GU Y61 ZD30DDT 3L Diesel Navara D22 D40 4cyl

Dimension:160*115*115mm

Weight:0.5kg



Price : (AUD)

IP-HLN001 / IDLER PULLEY HOLDEN COMMODORE SMOOTH VN VP VR VX VY WH WK V6 3.8L 88-04 38005

Dimension:93*55*93mm

Weight:0.3kg



Price : (AUD)

IP-HLN002 / Holden Commodore VS VT VX VY 3.8L V6 Gates Tensioner Pulley 38006

Dimension:93*55*93mm

Weight:0.15kg



Price : (AUD)

IP-HLN003 / Holden Drive Belt Idler Pulley VS VT VX VU VY Commodore V6 Calais Berlina 38009

Dimension:93*55*93mm

Weight:0.3kg



Price : (AUD)

**IP-HLN004 / Ford Falcon Idler Pulley AU BA BF EF EL
AU1 2 Drive Belt Lower Petrol Ute 38015**

Dimension:93*55*93mm

Weight:0.15kg



Price : (AUD)

**TN-FD002 / Ford Drive Belt Tensioner Falcon AU 1/2/3
EF EL Fairlane NF NL DF DL 4.0L 6cyl**

Dimension:185*110*65mm

Weight:2kg



Price : (AUD)

**TN-MB001 / Pajero Drive Belt Tensioner Mitsubishi NM
NP NS NT NW Petrol V6 3.5L 2000-2012**

Dimension:185*110*65mm

Weight:2kg

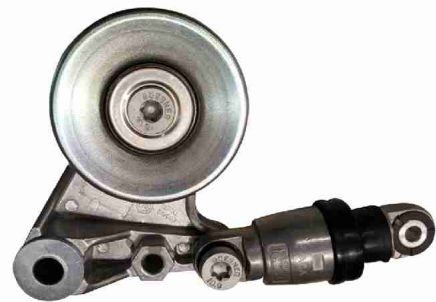

Price : (AUD)

**TB-NS001 / GU Patrol Drive Belt Tensioner for Nissan
3.0TDi ZD30 00-07 4cyl LWB Wagon 5Dr**

Dimension:304*172*85mm

Weight:1.25kg



Price : (AUD)

TN-HLN001 / New OEM Holden Commodore Drive Belt Tensioner Pulley VS VT VX VY V6 3.8L 95-04

Dimension:220*125*185mm

Weight:2kg



Price : (AUD)

TN-HLN002 / Holden Commodore Drive Belt A/C Tensioner VT VX VY VZ VE V8 5.7 LS1 GEN3 Pulley

Dimension:185*110*65mm

Weight:2kg



Price : (AUD)

TN-HLN004 / Drive Belt Tensioner Holden Commodore VE VT VX VY VZ V8 LS1 Gen3 Idler Tensioner

Dimension:185*110*65mm

Weight:2kg



Price : (AUD)

TN-NS001 / Patrol GU Drive Fan Belt Tensioner for Nissan ZD30 Turbo Diesel 00-07 3.0L 4cyl

Dimension:303*170*88mm

Weight:1kg



Price : (AUD)

TN-NS002 / Patrol Drive Belt Tensioner for GU Y61
ZD30DDTi ZD30DDT Diesel 3.0L 2000-2014

Dimension:45*45*125mm

Weight:0.25kg



Price : (AUD)

TN-NS004 / Patrol GU Drive Belt Tensioner Assembly
Nissan 2007-2014 4cyl ZD30DDTi 3.0L CRD

Dimension:185*110*65mm

Weight:1kg



Price : (AUD)

THE-HLN001 / HOLDEN THERMOSTAT 88-04
COMMODORE 3.8L V6 VN VP VQ VR VS VT VX VY
STATESMAN WH

Dimension:/

Weight:/



Price : (AUD)

GST-002 / OPEN BASE GASKET 4150 HOLLEY SQUARE
BORE 4 BARRY GRANT & EDELBROCK CARBS

Dimension:/

Weight:/

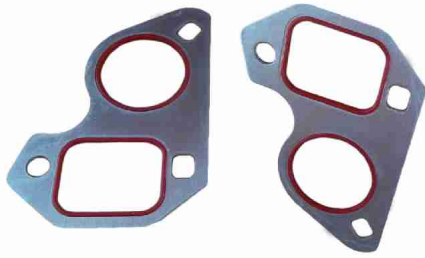

Price : (AUD)

**GST-003 / THERMOSTAT GASKET HOLDEN
COMMODORE VN VP VQ VR VS VT VX VY 3.8L V6
1988-2004**

Dimension: /

Weight: /

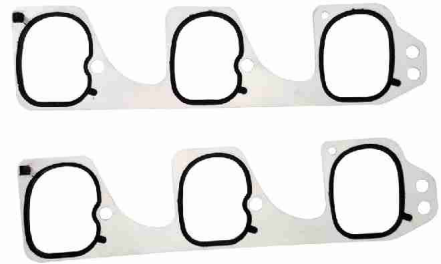

Price : (AUD)

**GST-HLN001 / INLET/INTAKE MANIFOLD
GASKET-HOLDEN COMMODORE VZ,VE,VF V6 3.6L
ALLOYTEC 04-4/13**

Dimension: /

Weight: /



Price : (AUD)

**TPS-HLN001 / Throttle Position Sensor switch Holden
Commodore VN VP VR VS VT 17106682 TPS**

Dimension: 55*35*73mm

Weight: 0.05kg



Price : (AUD)

**TPS-HLN002 / Throttle Position Sensor 3 Pins For
Holden Commodore V6 VS VT VU VX VY 17106681**

Dimension: 55*35*75mm

Weight: 0.1kg



Price : (AUD)

TPS-HLN003 / Holden LS1 Commodore 5.7L GEN 3 VT
VX VY HSV Throttle Position Sensor

Dimension:75*65*65mm

Weight:0.1kg



Price : (AUD)

TPS-HLN004 / TPS Throttle Position Sensor fit Holden
Jackaroo 4JX1 3.0L Diesel 98-02 97372851

Dimension:/

Weight:/



Price : (AUD)

SKAPB-TA001 / Steering Knuckle Arm Pivot Ball Hilux
RN36 RN46 YN60 YN63 YN65 Drop Boomerang

Dimension:/

Weight:/



Price : (AUD)

TR-HLN001 / Holden TIE ROD END steering adjuster Bar
HQ HJ HX HZ WB NEW PAIR AU Stock

Dimension:250*105*80mm

Weight:1kg



Price : (AUD)

TRE-TA001 / Landcruiser BJ40 BJ42 FJ40 FJ45 HJ45
HJ47 Tie Rod Relay End Kit 4X4 LHD 5pcs

Dimension:390*90*50mm

Weight:1.75kg



Price : (AUD)

TRE-TA003 / Landcruiser HJ75 FJ70 FJ73 BJ70 Tie Rod
End Kit Toyota 70 75 Series Steering RHD

Dimension:250*105*80mm

Weight:2.95kg



Price : (AUD)

TRE-TA005 / Steering Joint Tie Rod Relay End Kit
Toyota Landcruiser 70 75 HZJ75 FZJ75 FJ75

Dimension:250*105*80mm

Weight:3.05kg



Price : (AUD)

**TCKIT-HLN001 / PREMIUM Holden Commodore VZ VE
VF Alloytec LY7 LE0 LLT 3.6L V6 Timing Chain Kit**

Dimension:440*220*110mm

Weight:3.55kg



Price : (AUD)

**TOWBAR-001 / 2" TOWBAR TONGUE BALL MOUNT
HITCH TOW BAR TOWING 5000LBS HAYMAN REESE
TYPE TJM**

Dimension:425*120*68mm

Weight:8.4kg



Price : (AUD)

**TOWBAR-002 / 2" DROP 3/4" RISE TOWBAR TONGUE
BALL HITCH SUIT HAYMAN REECE, ARB TJM 5000LBS**

Dimension:/

Weight:3kg



Price : (AUD)
**TOWBAR-003 / HEAVY DUTY 4000KG EXTREME
 ADJUSTABLE TOW BALL MOUNT TOWBAR TONGUE
 HITCH 4TON**

Dimension:/
 Weight:6kg



Price : (AUD)
**TOWBAR-004 / 2" X 2" ADJUSTABLE TOWBAR TONGUE
 BALL MOUNT HITCH FOR SQUARE RECEIVERS**

Dimension:/
 Weight:6.55kg



Price : (AUD)
**TOWBAR-005 / Multi Use Dual Towbar Tow Bar Ball
 Mount Tongue Hitch Trailer 4WD Car Bike Rack**

Dimension:/
 Weight:5.5kg



Price : (AUD)
**TOWBAR-006 / Recovery Hitch Tow Bar Receiver 5
 Tonne Rating With Bow Shackle Off Road 4WD 4X4**

Dimension:/
 Weight:3.3kg



Price : (AUD)
 Towbar-HB / CHROME TOW BALL 50MM - 3500KG - TRAILER PART HITCH TOWBALL 4WD

Dimension: /
 Weight: 0.85kg



Price : (AUD)
 Towbar-HP / 16MM 5/8" HITCH PIN & R CLIP TOWBAR TOWING 4WD TRAILER BALL MOUNT RATED 3500KG

Dimension: /
 Weight: 0.24kg

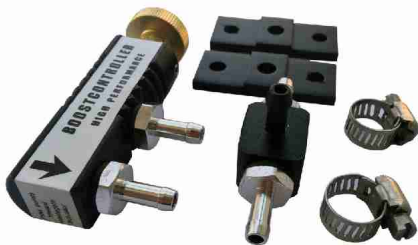

Price : (AUD)
 TBC-BLACK / Nissan Mitsubishi Turbo Black Boost Controller Incabin adjustable + fitting Kit

Dimension: 210*135*68mm
 Weight: 0.25kg



Price : (AUD)
 TBC-BLUE / Adjustable Blue Turbo Boost Controller Incabin Fitting Kit BMW Benz Volkswagen

Dimension: 210*135*68mm
 Weight: 0.25kg



Price : (AUD)
**VALVE-001 / Dawes Valve Needle valve GU Patrol ZD30
 MANUAL BOOST CONTROL Heavy Duty Spring**

Dimension: /
 Weight: /



Price : (AUD)
**UJ-FD001 / UNIVERSAL U-JOINT FOR MOST LAND
 ROVER DISCOVERY 91 ON DRIVE SHAFT FRONT OR
 REAR**

Dimension: 70*70*30mm
 Weight: 0.5kg



Price : (AUD)
**UJ-MB001 / One Uni. Joint L200 L300 Pajero Triton
 Starion Starwagon Triton MA MD MB SE SF**

Dimension: 70*70*30mm
 Weight: 0.5kg



Price : (AUD)
 UJ-SU001 / Universal Joint Suzuki Jimny Sierra 1.0/1.3
 Maruti 1.0 Drover (11/84-99) Ø 25 mm

Dimension:70*70*30mm
 Weight:0.6kg



Price : (AUD)
 UJ-TA001 / Uni Universal Joint Toyota Landcruiser 80
 Series HJ60 HDJ80 FJ40/43/45 80-97

Dimension:100*100*32mm
 Weight:0.75kg



Price : (AUD)
 UJ-TA002 / Hilux KUN26R KZN165R LN106R 107R 111R
 167R RUJ2109 DYNA 150 Universal Joint

Dimension:100*100*32mm
 Weight:0.55kg



Price : (AUD)
 UJ-TA003 / TOYOTA LANDCRUISER UNIVERSAL JOINT
 DYNA 200,300,400 series RUJ 2041 32mm od

Dimension:100*100*32mm
 Weight:0.75kg

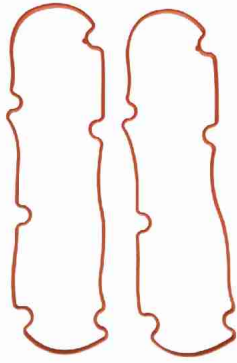

Price : (AUD)

**VCG-HLN001 / HOLDEN ROCKER COVER GASKETS
COMMODORE V6 3.8L Calais Caprice Monaro Statesman**

Dimension: /
Weight: 0.2kg



Price : (AUD)

**WP-BMW001 / Coolant Water Pump BMW E36 E46 E30
E34 316i 318i Z3 Heavy Duty Compact Cabrio**

Dimension: /
Weight: /



Price : (AUD)

**WP-FD001 / Ford & Mazda Water Pump Courier PD PE
PG PH Bravo B2500 WL Diesel Ute 8ALA15100**

Dimension: 175*140*130mm
Weight: 1.1kg



Price : (AUD)

**WP-FD004 / Ford Transit Water Pump VH VJ VM D4FA
VAN UTE 4cyl 2.4L 2000-2010 Turbo Diesel**

**Dimension:/
Weight: /**



Price : (AUD)

**WP-HLN001 / Holden 3.8L V6 Water Pump +Gasket
Commodore VN VP VR VS VT VU VX VY 1988-7/2004**

**Dimension:250*160*110mm
Weight:1.25kg**



Price : (AUD)

**WP-HLN002 / Holden Commodore Water Pump Berlina
Calais Statesman V6 VZ VE WL WM 3.6L +Gasket**

**Dimension:250*160*110mm
Weight:1kg**



Price : (AUD)

**WP-HLN003 / GTO Firebird Water Pump for Chevrolet
Corvette Camaro Pontiac 5.7L 6.0L**

**Dimension:70*60*85mm
Weight:3.65kg**

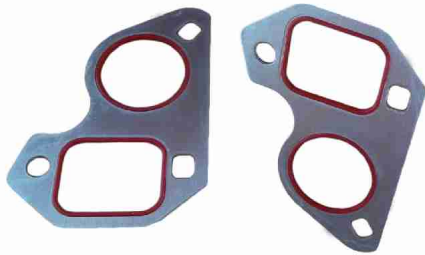

Price : (AUD)

WP-HLN003GST / Water Pump Gaskets Kit for Camaro
Corvette GTO Firebird LS1 LS6 5.7L AW5081

Dimension: /
Weight: /

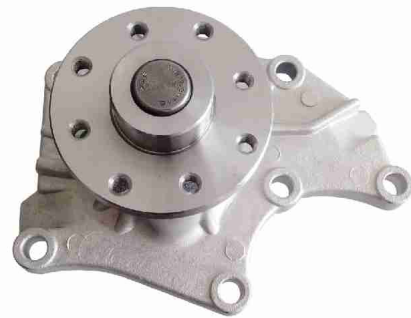

Price : (AUD)

WP-HLN004 / Engine Water Pump Holden Jackaroo
UBS55 1989-1992 4cyl 4JB1-T 2.8L Turbo Diesel

Dimension: 250*160*110mm
Weight: 2kg



Price : (AUD)

WP-HLN005 / Jackaroo & Rodeo Water Pump Holden
UBS17 TFR17 TFS17 GWIS-31A 2.6L Petrol 4cyl

Dimension: 175*140*130mm
Weight: 1.5kg



Price : (AUD)

WP-MA001 / Water Pump Mazda 323 BF BG MX-5 NA
B6-T 1.6L Turbo 1.8L BP-DOHC 1.8L Petrol 16V

Dimension: 250*160*110mm
Weight: 2kg

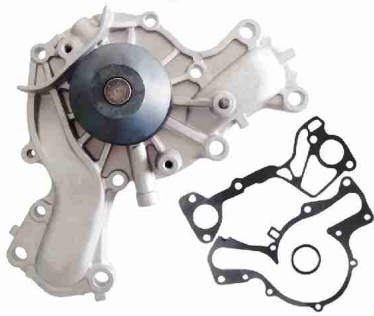

Price : (AUD)

**WP-MB001 / Mitsubishi Water Pump Magna TR TS 6cyl
6G72-S2 3.0L Petrol V6 Engine 1993-1996**

Dimension:160*110*250mm

Weight:1.3kg



Price : (AUD)

**WP-MB002 / Mitsubishi Water Pump Pajero NJ NK NL
2.8 4M40 4M40T 4M41 Triton MK 1993-2006**

Dimension:210*155*165mm

Weight:1.15kg

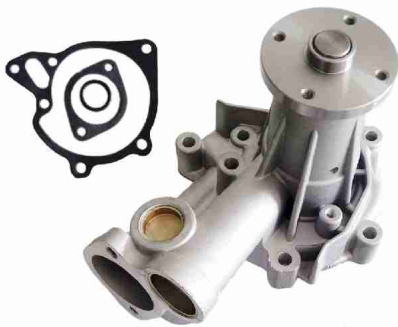

Price : (AUD)

**WP-MB004 / Mitsubishi Water Pump Pajero NA -NG
Diesel 4D55 4D56 Triton ME MF MG MH MJ 2.3L**

Dimension:210*155*165mm

Weight:2.15kg



Price : (AUD)

**WP-MB005 / Water Pump Pajero NA-NH 83-93 Triton
ME-MJ 86-96 Diesel 2.6L 4cyl Mitsubishi**

Dimension:210*155*165mm

Weight:1kg

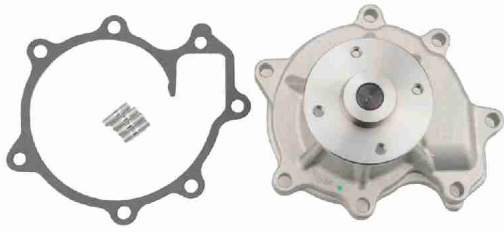

Price : (AUD)

**WP-NS002 / Water Pump for Nissan Patrol GQ Y60
TB42S TB42E Ford Maverick 4.2L Petrol 88-97**

Dimension:160*130*115mm

Weight:1.3kg



Price : (AUD)

**WP-NS003 / Water Pump for Nissan Patrol TD42 4.2L
Diesel GQ GU Y60 Y61 Safari Turbo Ford DA**

Dimension:210*155*165mm

Weight:3kg



Price : (AUD)

**WPFC-NS01 / Water Pump + Fan Clutch fit Nissan Patrol
GU 2000-1/07 4cyl ZD30 3.0TDi Diesel**

Dimension:270*170*160mm

Weight:3.2kg



Price : (AUD)

**WP-TA004 / Toyota Engine Water Pump Hilux LN86
LN106 LN107 LN111 LN147 LN167 Ute 3L Diesel**

Dimension:/

Weight:1.15kg



Price : (AUD)

WP-TA006 / Landcruiser HDJ78 HDJ79 HDJ80 Water Pump Toyota Turbo Diesel 6cyl 4.2L 1HD-FTE

Dimension:160*130*115mm

Weight:2kg



Price : (AUD)

WP-TA007 / OEM Quality Water Pump Toyota Landcruiser HJ47 HJ60 HJ61 HJ75 4.0L 6cyl Diesel

Dimension:125*125*125mm

Weight:1.75kg



Price : (AUD)

WPKIT-TA006 / Timing Belt Tensioner Water Pump Kit Landcruiser HZJ75 HZJ80 1HZ 4.2L Diesel

Dimension:/

Weight:/

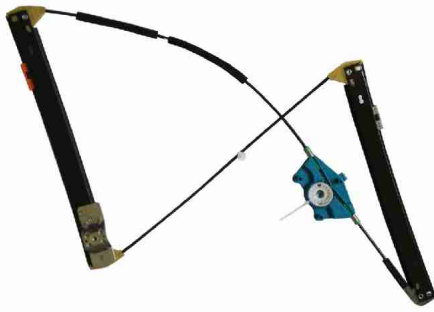

Price : (AUD)

**WR-AU001L / Power Window Regulator Audi A4 S4
Front Left LH Electric No Motor 02~08 8E B6**

Dimension:545*440*47mm

Weight:1.4kg



Price : (AUD)

**WR-AU001R / Audi A4 S4 Window Regulator 8E B6
8E0837462B Front Right Side 02-08**

Dimension:545*440*47mm

Weight:1.4kg



Price : (AUD)

**WR-BMW001L / Window Regulator BMW 3 Series E46
Front Left Hand 316i 318i 320i 323i 328i 330i**

Dimension:565*27*65mm

Weight:1.35kg



Price : (AUD)

**WR-BMW001R / BMW Window Regulator 3 Series 318i
320i 323i 328i Sedan F&R 8/98 - 5/05 Drive**

Dimension:565*27*65mm

Weight:1.35kg



Price : (AUD)

**WR-BMW002L / Window Regulator BMW 3 Series E46
318i 320i 323i 325i 328i 330i Left Hand Rear**

Dimension:570*24*65mm

Weight:0.7kg



Price : (AUD)

**WR-BMW002R / BMW 3 Series Window Regulator E46
Rear Right Side 316i 318i 320i 323i 325i 328i**

Dimension:570*24*65mm

Weight:0.7kg



Price : (AUD)

**WS-FD001 / Ford AU Falcon Fairmont Fairlane Single
Power Window Switch 7 Pin Type 1998-2002**

Dimension:54*30*55mm

Weight:0.05kg



Price : (AUD)

**WS-HLN001 / Holden Commodore VT VX Electric Power
Window Master Control Switch 1999-2002**

Dimension:90*60*12mm

Weight:0.15kg



Price : (AUD)

WS-HLN002 / Holden Commodore VY VZ Power Master Window Switch 13 Pins 92111628

**Dimension:140*756*70mm
Weight:0.15kg**



Price : (AUD)

WS-HLN003 / Power Window Master Switch 2 Button fits Holden Commodore VY VZ 02-06 Ute Black

**Dimension:140*756*70mm
Weight:0.15kg**



Price : (AUD)

WS-TA001 / Electric Main Window Switch Front Right Toyota Landcruiser 80 Series 1990-1998

**Dimension:188*90*55mm
Weight:0.2kg**



Price : (AUD)

WS-TA003 / TOYOTA 70 80 Landcruiser Camry DV10 Prado 95 Hiace Power Single Window Switch

**Dimension:40*25*50mm
Weight:0.05kg**



Price : (AUD)

**WWP-BMW01 / Windscreen Washer Pump BMW 3/5/X/Z
Series E36 E46 E53 E83 E85 E86 F11 F25 12V**

Dimension:115*45*35mm

Weight:0.073kg



Price : (AUD)

**WWP-FD01 / Windscreen Washer Pump For Ford Falcon
BA/BF/FG Front 12V 09/2002-2013**

Dimension:75*50*49mm

Weight:0.084kg



Price : (AUD)

**WWP-HLN02 / Windscreen Wiper Washer Bottle Pump
Motor KB TF Holden Rodeo 08/1980 - 02/2003**

Dimension:60*45*85mm

Weight:/



Price : (AUD)

**WWP-NS01 / Wiper Washer Pump Windscreen fit Nissan
Patrol GQ Y60 Ford Maverick DA Petrol**

Dimension:55*55*100mm

Weight:0.25kg



Price : (AUD)

**WWP-NS02 / Windscreen Wiper Washer Pump for Patrol
GU Y61 97-04 4.2TD 2.8TD Front Pair Set**

Dimension:90*60*45mm

Weight:0.073kg



Price : (AUD)

**WWP-TA001 / Brand New Wiper Washer Pump Toyota
Landcruiser FJ40 BJ40 BJ42 FJ45 HJ47 FJ55**

Dimension:/

Weight:/



Price : (AUD)

**WWP-UNI01 / Windscreen Window Washer Pump Spray
Motor 12 V For Most Japanese Cars**

Dimension:78*57*50mm

Weight:0.08kg



Price : (AUD)

**WWP-UNI02 / Windscreen / Windshield Washer Bottle
Kit Universal 12V Switch Wiring Jets**

Dimension:60*60*120mm

Weight:0.41kg



Price : (AUD)

WWB-HLN001 / Commodore Berlina Calais Windscreen Wiper Blade Frameless Holden VE *Express*

Dimension:720*50*40mm

Weight:0.25kg



Price : (AUD)

BRKIT-TA001 / Toyota Nissan Mitsubishi Breather Kit 4 Port Diff Hilux Landcuser Patrol Triton

Dimension:/

Weight:/



Price : (AUD)

CVV-BMW001 / Crankcase Vent Valve BMW E36 E46 316i 318i 318ti 318is 518i Z3 11157501567 PCV

Dimension:/

Weight:/



Price : (AUD)

EB-FD001 / EXTRACTOR BOLTS 3/8" 16pcs FORD CLEVELAND WINDSOR XR XT XW XY 302 351 Silver

Dimension:305*140*125mm

Weight:0.5kg

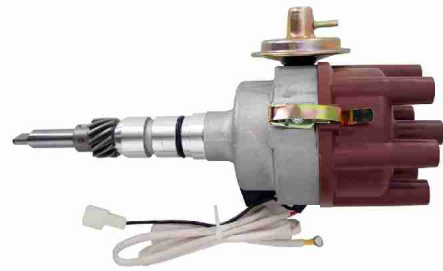

Price : (AUD)

EDIS-TA001 / Electronic Distributor Fit Toyota Land Cruiser FJ40-FJ80 2F 3F 4.2L 4.0L

Dimension: /

Weight: /



Price : (AUD)

LIFTER-CR001 / LS7 Roller Hydraulic Valve Lifter S1 LS2 LS3 L76 L77 L98 Commodore GM Heavy Duty

Dimension: /

Weight: /